

AFRICAN CHAMPIONSHIP SENIOR



TUNIS (TUN)

2014-03-28 - 2014-03-30 2014

Résultats - Results

Lutte Libre - Free-Style



**Liste des arbitres / Referee list****African Championship Senior**

| N° | Licence | Pays Country | Nom - Last Name | Prénom - First Name |
|-----------|----------------|-------------------------|------------------------|----------------------------|
| | | ALG | DOGHDOGH | Hamza |
| | | ALG | FETIAR | Riadh |
| | | ALG | MERDADI | Faouzi |
| | | ALG | NAANAA | Yacine |
| | | ALG | SIGUERDJDJENE | Omar |
| | | ALG | TRAI | Belcacem |
| | | EGY | AHMAD ZAKI | Salman |
| | | EGY | HALAWA | Cherif Ali |
| | | EGY | MOHAMED | Etman |
| | | JOR | MAHMOUD | Alaziz |
| | | JOR | MUNIERAL | Sallaq |
| | | JOR | NAIEF | Aloush |
| | | MAR | ZAIMI | Abdallah |
| | | NGR | USMAN | Yusuf |
| | | SAM | CHARLE | Vallet |
| | | SEN | NGOM | Malik |
| | | TUN | BOUSLAHI | Mohamed |
| | | TUN | KHARAZI | Jamel |
| | | TUN | MANAI | Hedi |
| | | TUN | ZERMDINI | Tayeb |

Nombre d'arbitres - Number of Referee

20



Liste des nations / Countries List

African Championship Senior

STYLE FS



Pays - Country

| | | |
|---|---------------|-----|
|  | ALGERIA | ALG |
|  | CAMEROON | CMR |
|  | CHAD | CHA |
|  | CONGO | CGO |
|  | EGYPT | EGY |
|  | GUINEA-BISSAU | GBS |
|  | ILE MAURICE | MRI |
|  | MADAGASCAR | MAD |
|  | MOROCCO | MAR |
|  | NAMIBIE | NAM |
|  | NIGERIA | NGR |
|  | SENEGAL | SEN |
|  | SOUTH AFRICA | RSA |
|  | TUNISIA | TUN |

Nombre de nations - Number of Countries 14

**Nombre d'engagés par nation / Number of Entries By Country****African Championship Senior**

STYLE FS



| Pays - Country | 125 KG | 57 KG | 61 KG | 65 KG | 70 KG | 74 KG | 86 KG | 97 KG | TOTAL |
|-----------------------|---------------|--------------|--------------|--------------|--------------|--------------|--------------|--------------|--------------|
| ALG | | 1 | 1 | 1 | 1 | 1 | 1 | 1 | 7 |
| CGO | | 1 | | 1 | 1 | | | | 3 |
| CHA | 1 | 1 | 1 | 1 | 1 | | | 1 | 6 |
| CMR | 1 | 1 | | 1 | 1 | 1 | 1 | | 6 |
| EGY | 1 | | 1 | 1 | 1 | 1 | 1 | 1 | 7 |
| GBS | | | | | 1 | 1 | | | 2 |
| MAD | | | | 1 | | | | | 1 |
| MAR | 1 | 1 | 1 | 1 | 1 | 1 | 1 | 1 | 8 |
| MRI | | 1 | | | | | | | 1 |
| NAM | | | 1 | | | | | 1 | 2 |
| NGR | 1 | 1 | 1 | 1 | | 1 | 1 | 1 | 7 |
| RSA | | | 1 | 1 | | 1 | 1 | | 4 |
| SEN | 1 | | 1 | | 1 | 1 | 1 | | 5 |
| TUN | 1 | 1 | 1 | 1 | 1 | 1 | 1 | 1 | 8 |
| TOTAL | 7 | 8 | 9 | 10 | 9 | 9 | 8 | 7 | 67 |

Nombre de nations - Number of Countries **14**



Liste des Engagés par pays / Entry-List By Country

African Championship Senior

STYLE FS

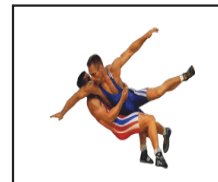

ALGERIA (ALG)

Lutteur(s) / Wrestler(s) :

| | |
|-------|---------------------|
| 57 kg | KHERBACH, Abdelhak |
| 61 kg | SAYEH, Abderrahim |
| 65 kg | LALOUCHE, Nasrallah |
| 70 kg | BOUDRAA, Mohamed |
| 74 kg | MOUSSAOUI, Hamza |
| 86 kg | LOUAFI, Med Riad |
| 97 kg | BOUZID, Lounes |

CAMEROON (CMR)

Lutteur(s) / Wrestler(s) :

| | |
|--------|-------------------------|
| 125 kg | KOUAMEN, Mbianga claude |
| 57 kg | ESSINDI, Sengui Boris |
| 65 kg | MBEGHAM, Tengoh Alain |
| 70 kg | FOKAM, William Celestin |
| 74 kg | DJOUMESSI, Romeo |
| 86 kg | DIBOMA, Moncel |

CHAD (CHA)

Lutteur(s) / Wrestler(s) :

| | |
|--------|---------------------|
| 125 kg | DIEUDONNE, Basile |
| 57 kg | HERE, Hel |
| 61 kg | ALLOUMA, Kouzoumbi |
| 65 kg | IDRISS, Hamadi |
| 70 kg | MADJIADOUM, Kasimir |
| 97 kg | MALICK, Djackna |

CONGO (CGO)

Lutteur(s) / Wrestler(s) :

| | |
|-------|-----------------|
| 57 kg | MBAMBI, Prince |
| 65 kg | MBE, Jean |
| 70 kg | NGOUEMA, Victor |

EGYPT (EGY)

Lutteur(s) / Wrestler(s) :



Liste des Engagés par pays / Entry-List By Country

African Championship Senior

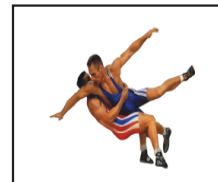

STYLE FS

| | |
|--------|------------------------|
| 125 kg | OTHMAN, Ahmed |
| 61 kg | AHMED SAIED, Abdelaziz |
| 65 kg | FAHMY, Haitham |
| 70 kg | IBRAHIM, Ayed |
| 74 kg | SAYID, Abdelmanhim |
| 86 kg | ZAGHLOL, Mohamed |
| 97 kg | MOUSTAFA, Mohamed |

GUINEA-BISSAU (GBS)

Lutteur(s) / Wrestler(s) :

| | |
|-------|------------------|
| 70 kg | INTIPE, Quintino |
| 74 kg | MIDANA, Augusto |

MADAGASCAR (MAD)

Lutteur(s) / Wrestler(s) :

| | |
|-------|-------------------------------|
| 65 kg | RAZAFIMANOKA, Mahatia Tinaihi |
|-------|-------------------------------|

MAURITIUS (MRI)

Lutteur(s) / Wrestler(s) :

| | |
|-------|------------------------------|
| 57 kg | BANDOU JEAN, Cuylitane Joris |
|-------|------------------------------|

MOROCCO (MAR)

Lutteur(s) / Wrestler(s) :

| | |
|--------|------------------------|
| 125 kg | EL MKABER, Anas |
| 57 kg | NAZIH, Mohamed |
| 61 kg | OULED BENTLE, Radouane |
| 65 kg | FAJARI, Fouad |
| 70 kg | SARDY, Yassine |
| 74 kg | BOUALEM, Aziz |
| 86 kg | MOUNISS, Reda |
| 97 kg | BOUMADIENE, Hamza |

NAMIBIA (NAM)

Lutteur(s) / Wrestler(s) :

| | |
|-------|-------------------------|
| 61 kg | SHILMELA, Nataele |
| 97 kg | SHIKONGO, Angola Mateus |



Liste des Engagés par pays / Entry-List By Country

African Championship Senior

STYLE FS

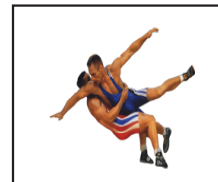

NIGERIA (NGR)

Lutteur(s) / Wrestler(s) :

| | |
|--------|---------------------|
| 125 kg | BOLTIC, Siniye |
| 57 kg | EBIKEWENIMO, Welson |
| 61 kg | RIRSTMAN, Victor |
| 65 kg | CHARKSON, Sampson |
| 74 kg | BIBO, Melvin |
| 86 kg | OPUKIRI, Agala |
| 97 kg | TAMARAU, Sosu |

SENEGAL (SEN)

Lutteur(s) / Wrestler(s) :

| | |
|--------|----------------------|
| 125 kg | THIAKA, Faye |
| 61 kg | DIATTA, Jean Bernard |
| 70 kg | DIATTA, Nicola |
| 74 kg | BASSIZOU, Camara |
| 86 kg | SERIGNE MBACKE, Ngom |

SOUTH AFRICA (RSA)

Lutteur(s) / Wrestler(s) :

| | |
|-------|--------------------|
| 61 kg | PLAATJIES, Marno |
| 65 kg | SMITH, Ivan |
| 74 kg | MEYER, Gerald |
| 86 kg | HIETBRINK, Armando |

TUNISIA (TUN)

Lutteur(s) / Wrestler(s) :

| | |
|--------|--------------------|
| 125 kg | TRABELSI, Slim |
| 57 kg | MATHLOUTHI, Chedli |
| 61 kg | BELAIYECH, Heitham |
| 65 kg | GHANMI, Maher |
| 70 kg | AYARI, Ali |
| 74 kg | AYACHI, Borhen |
| 86 kg | KEDIDI, Imed |
| 97 kg | SAADAWI, Mohamed |



Feuille de compétition / Competition Sheet

African Championship Senior

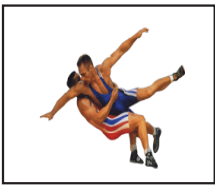

STYLE : FS 125 kg

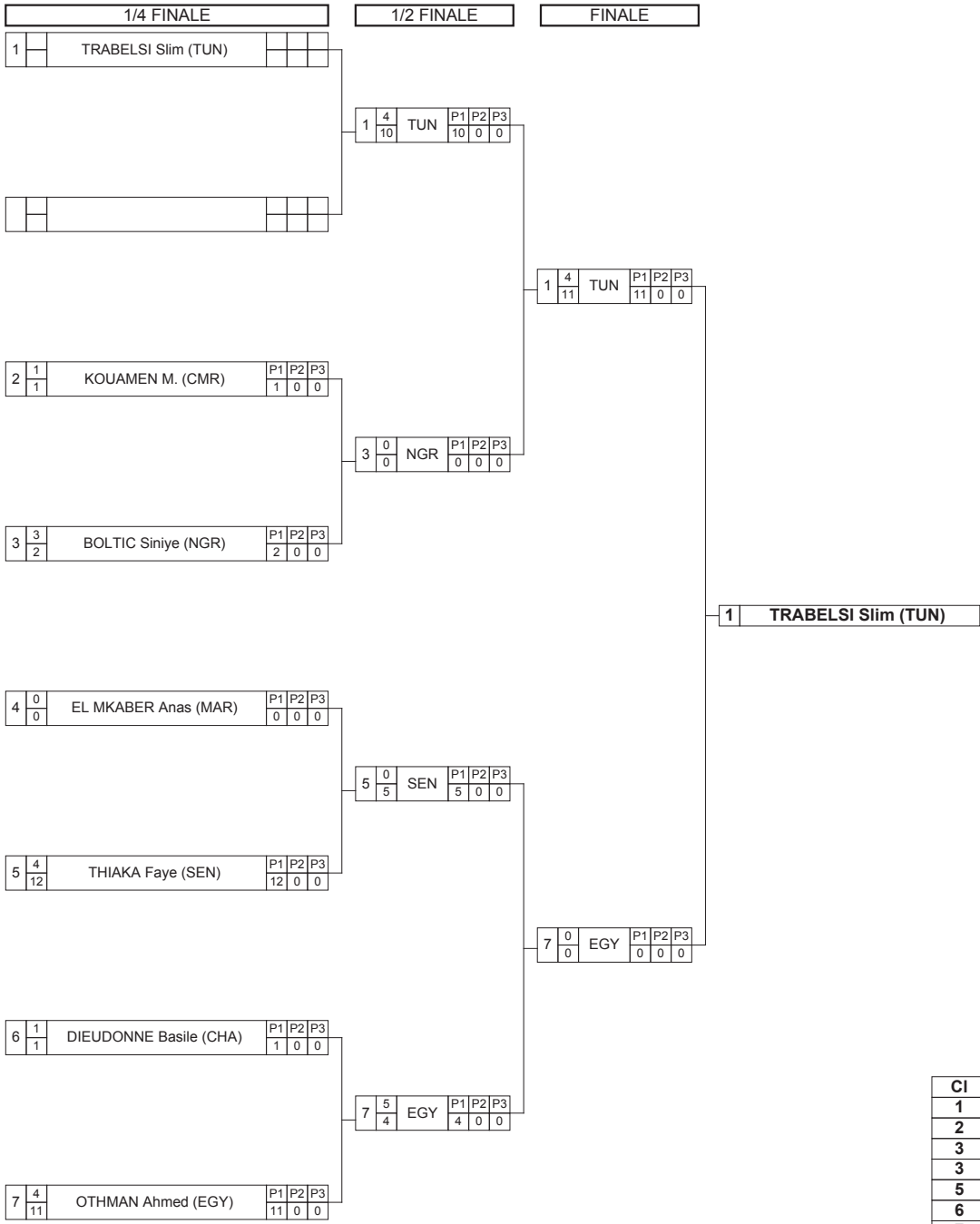

Classement

| Cl | Pays | Nom |
|----|------|------------------------|
| 1 | TUN | TRABELSI Slim |
| 2 | EGY | OTHMAN Ahmed |
| 3 | NGR | BOLTIC Siniye |
| 3 | SEN | THIAKA Faye |
| 5 | CHA | DIEUDONNE Basile |
| 6 | CMR | KOUAMEN Mbianga claude |
| 7 | MAR | EL MKABER Anas |

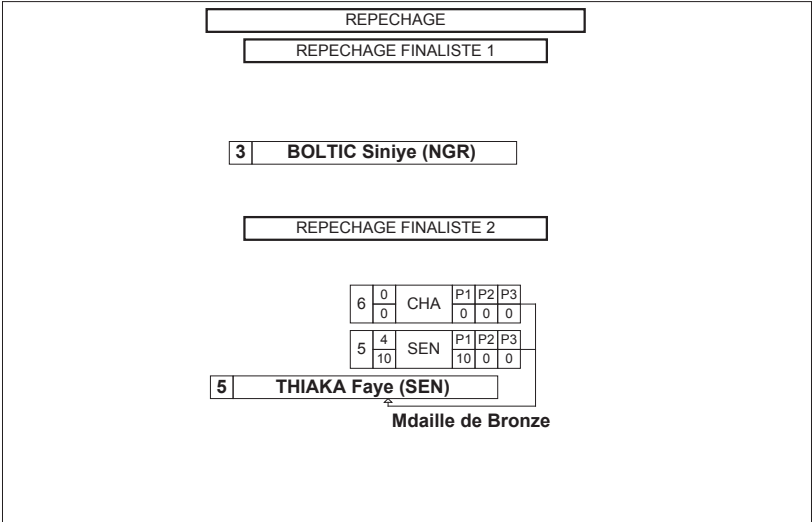



Classement

African Championship Senior

STYLE : FS 125 kg



1 - Or / Gold



TRABELSI Slim

2 - Argent / Silver



OTHMAN Ahmed

3 - Bronze



BOLTIC Siniye



THIAKA Faye

| <i>Classement</i> | <i>Nom - Name</i> | <i>Pays - Country</i> |
|-------------------|-------------------|-----------------------|
| 1 | TRABELSI Slim | TUN |
| 2 | OTHMAN Ahmed | EGY |
| 3 | BOLTIC Siniye | NGR |
| 3 | THIAKA Faye | SEN |
| 5 | DIEUDONNE Basile | CHA |
| 6 | KOUAMEN M. | CMR |
| 7 | EL MKABER Anas | MAR |



Feuille de compétition / Competition Sheet

African Championship Senior

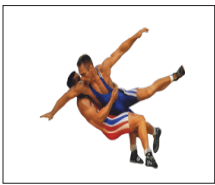

STYLE : FS 57 kg

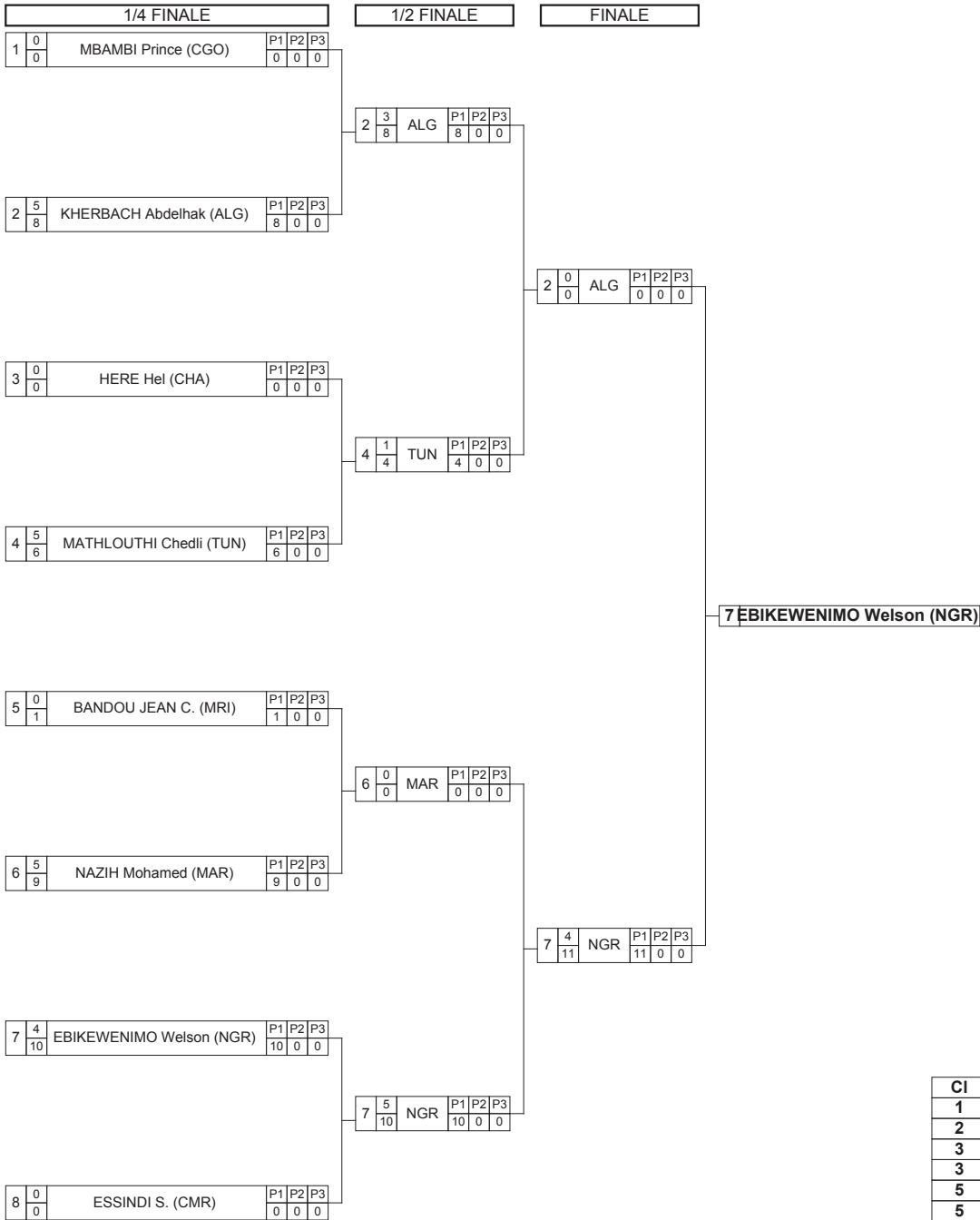

Classement

| Cl | Pays | Nom |
|----|------|------------------------------|
| 1 | NGR | EBIKEWENIMO Welson |
| 2 | ALG | KHERBACH Abdelhak |
| 3 | CMR | ESSINDI Sengui Boris |
| 3 | TUN | MATHLOUTHI Chedli |
| 5 | MAR | NAZIH Mohamed |
| 5 | CGO | MBAMBI Prince |
| 7 | MRI | BANDOU JEAN Cuyilitane Joris |
| 8 | CHA | HERE Hel |

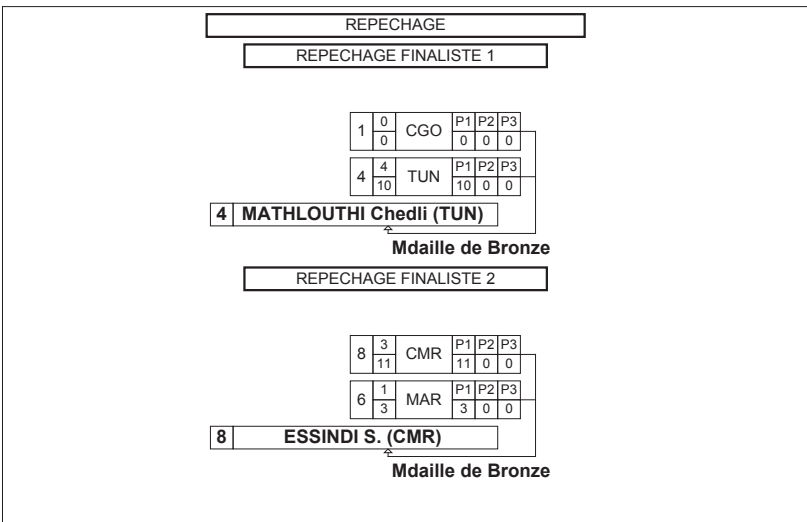



Classement

African Championship Senior

STYLE : FS 57 kg



1 - Or / Gold



EBIKEWENIMO Welson

2 - Argent / Silver



KHERBACH Abdelhak

3 - Bronze



ESSINDI Sengui Boris



MATHLOUTHI Chedli

| Classement | Nom - Name | Pays - Country |
|------------|--------------------|----------------|
| 1 | EBIKEWENIMO Welson | NGR |
| 2 | KHERBACH Abdelhak | ALG |
| 3 | ESSINDI S. | CMR |
| 3 | MATHLOUTHI Chedli | TUN |
| 5 | NAZIH Mohamed | MAR |
| 5 | MBAMBI Prince | CGO |
| 7 | BANDOU JEAN C. | MRI |
| 8 | HERE Hel | CHA |



Feuille de compétition / Competition Sheet

African Championship Senior



STYLE : FS 61 kg

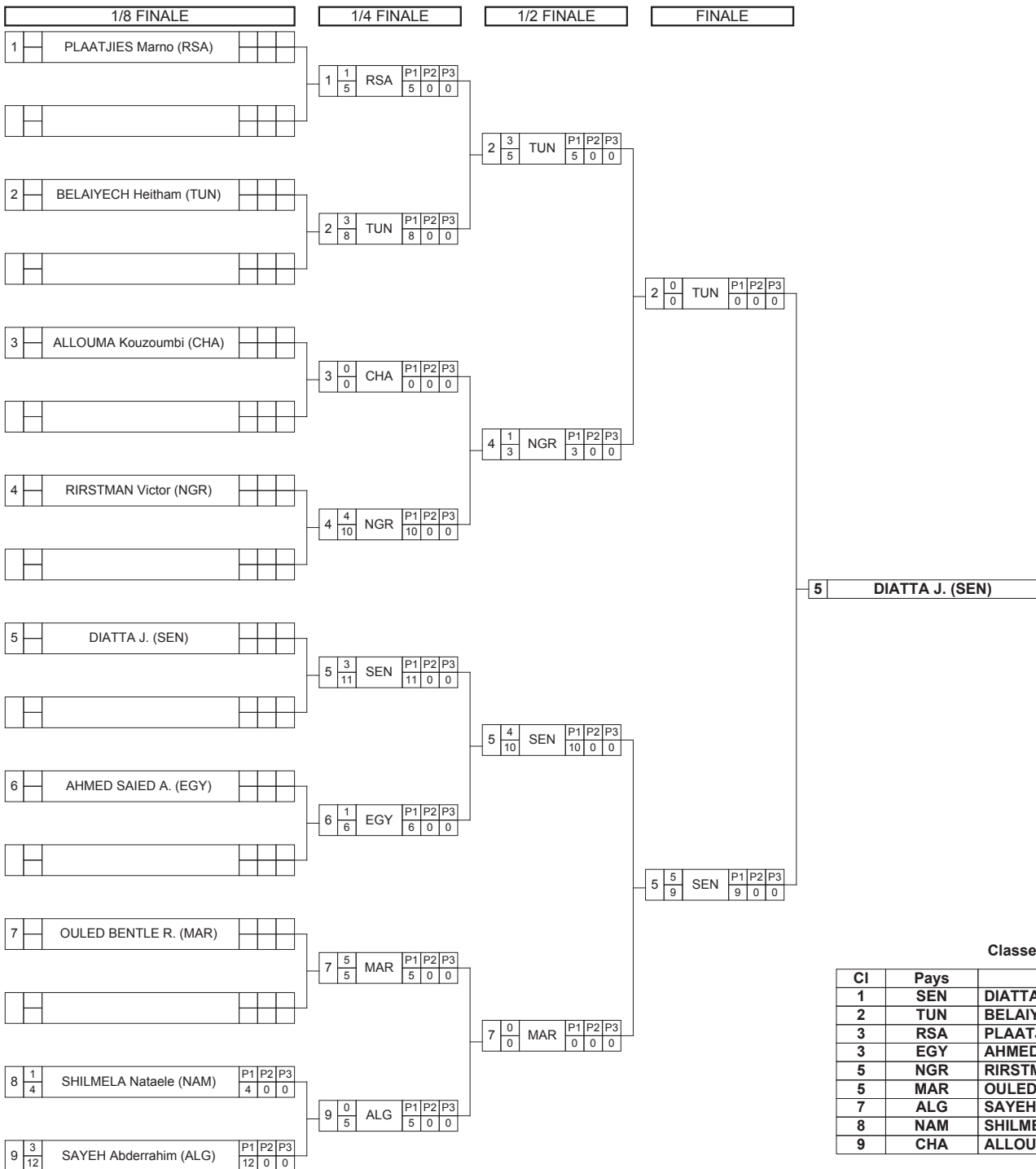

Classement

| Cl | Pays | Nom |
|----|------|-----------------------|
| 1 | SEN | DIATTA Jean Bernard |
| 2 | TUN | BELAIYECH Heitham |
| 3 | RSA | PLAATJIES Marno |
| 3 | EGY | AHMED SAIED Abdelaziz |
| 5 | NGR | RIRSTMAN Victor |
| 5 | MAR | OULED BENTLE Radouane |
| 7 | ALG | SAYEH Abderrahim |
| 8 | NAM | SHILMELA Nataele |
| 9 | CHA | ALLOUMA Kouzoumbi |

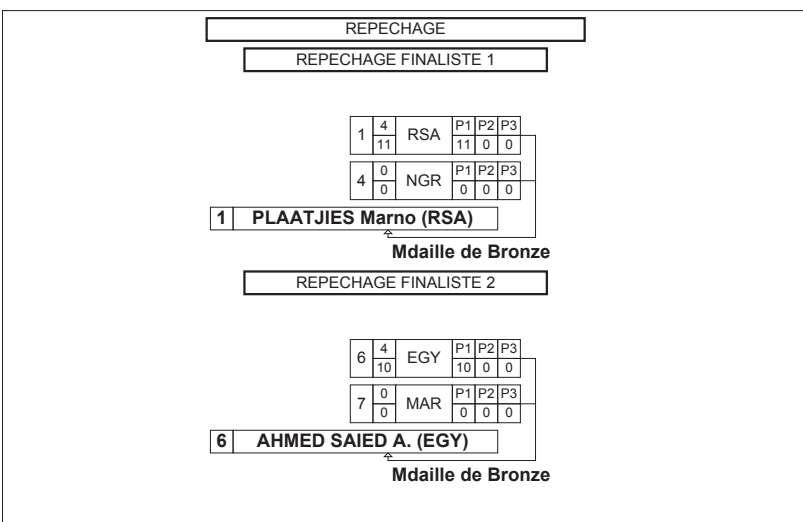



Classement

African Championship Senior

STYLE : FS 61 kg



1 - Or / Gold



DIATTA Jean Bernard

2 - Argent / Silver



BELAIYECH Heitham

3 - Bronze



PLAATJIES Marno



AHMED SAIED Abdelaziz

| Classement | Nom - Name | Pays - Country |
|------------|---------------------|----------------|
| 1 | DIATTA Jean Bernard | SEN |
| 2 | BELAIYECH Heitham | TUN |
| 3 | PLAATJIES Marno | RSA |
| 3 | AHMED SAIED A. | EGY |
| 5 | RIRSTMAN Victor | NGR |
| 5 | OULED BENTLE R. | MAR |
| 7 | SAYEH Abderrahim | ALG |
| 8 | SHILMELA Nataele | NAM |
| 9 | ALLOUMA Kouzoumbi | CHA |



Feuille de compétition / Competition Sheet

African Championship Senior

STYLE : FS 65 kg

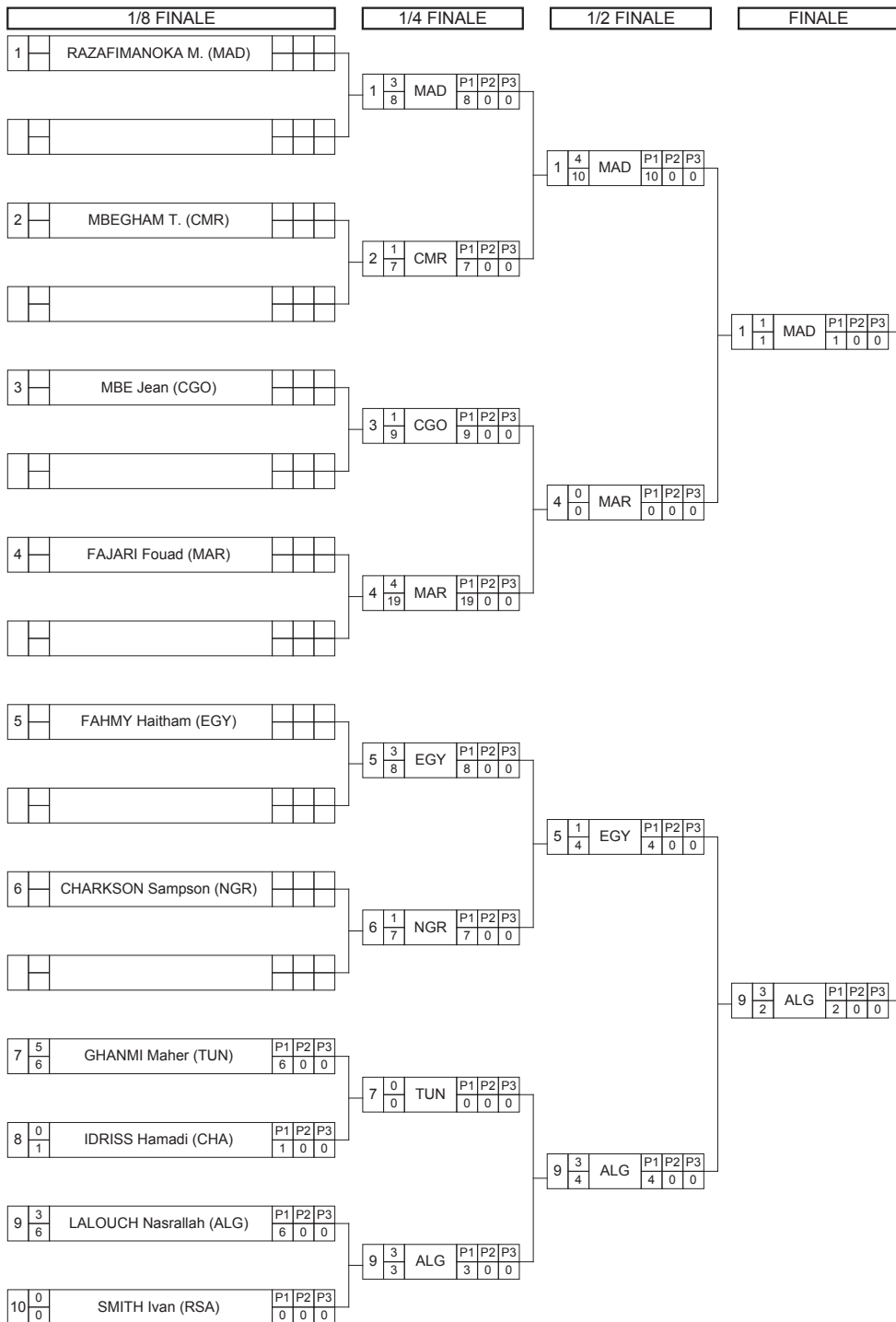

9 LALOUCH Nasrallah (ALG)

Classement

| Cl | Pays | Nom |
|----|------|------------------------------|
| 1 | ALG | LALOUCH Nasrallah |
| 2 | MAD | RAZAFIMANOKA Mahatia Tinaihi |
| 3 | CMR | MBEGHAM Tengoh Alain |
| 3 | TUN | GHANMI Maher |
| 5 | EGY | FAHMY Haitham |
| 5 | MAR | FAJARI Fouad |
| 7 | CGO | MBE Jean |
| 8 | NGR | CHARKSON Sampson |
| 9 | RSA | SMITH Ivan |
| 10 | CHA | IDRISS Hamadi |

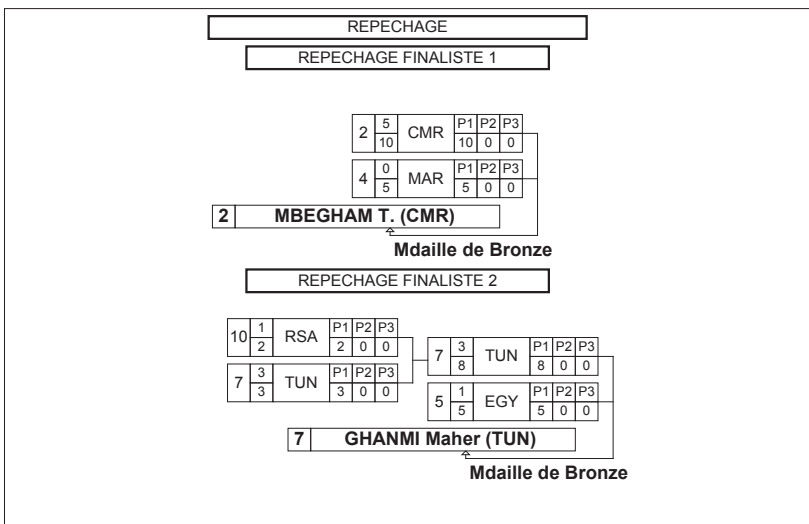



Classement

African Championship Senior



STYLE : FS 65 kg

1 - Or / Gold



LALOUCH Nasrallah

2 - Argent / Silver



RAZAFIMANOKA Mahatia Tinaihi

3 - Bronze



MBEGHAM Tengoh Alain



GHANMI Maher

| Classement | Nom - Name | Pays - Country |
|------------|-------------------|----------------|
| 1 | LALOUCH Nasrallah | ALG |
| 2 | RAZAFIMANOKA M. | MAD |
| 3 | MBEGHAM T. | CMR |
| 3 | GHANMI Maher | TUN |
| 5 | FAHMY Haitham | EGY |
| 5 | FAJARI Fouad | MAR |
| 7 | MBE Jean | CGO |
| 8 | CHARKSON Sampson | NGR |
| 9 | SMITH Ivan | RSA |
| 10 | IDRISS Hamadi | CHA |



Feuille de compétition / Competition Sheet

African Championship Senior

STYLE : FS 70 kg

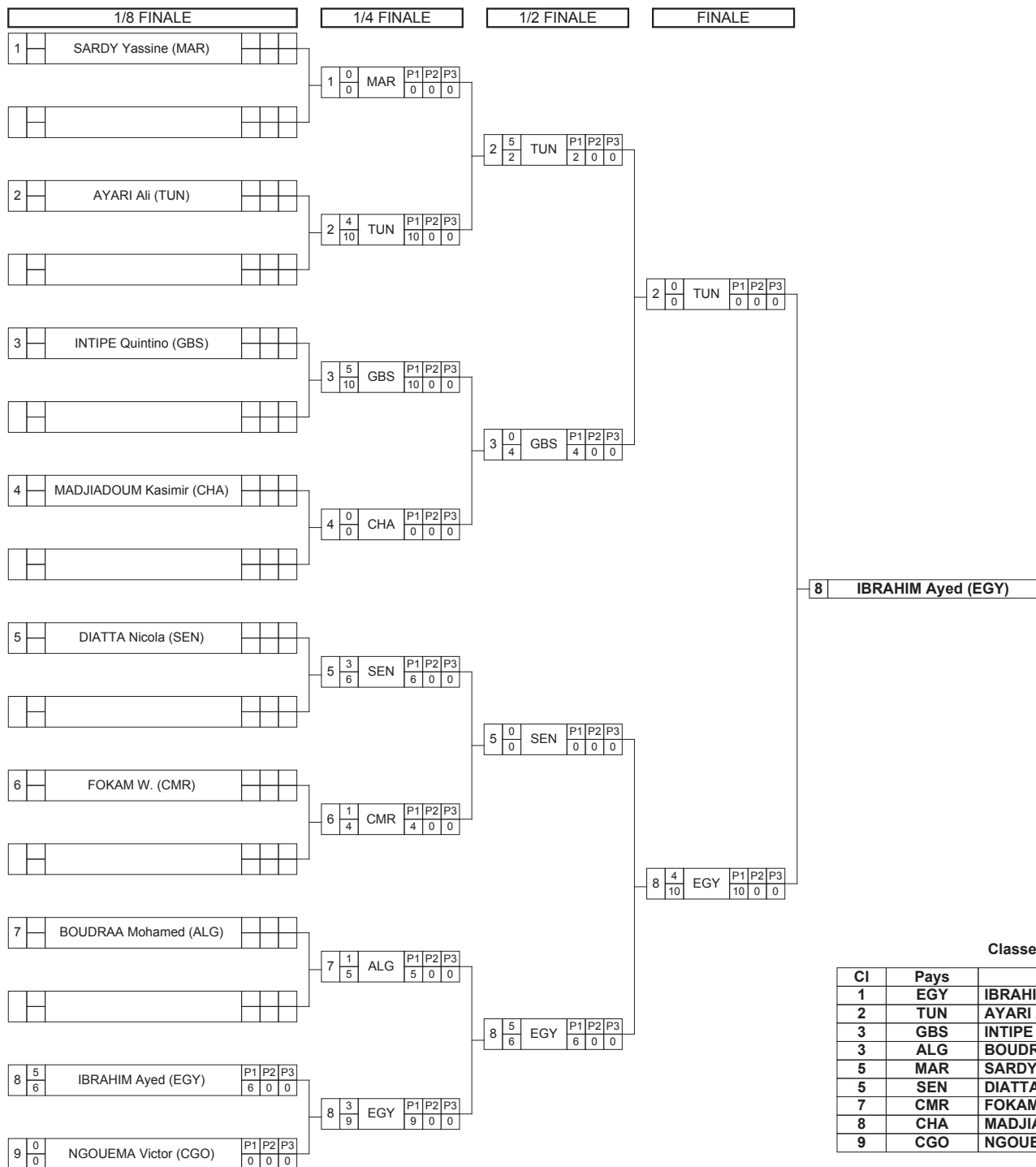

Classement

| Cl | Pays | Nom |
|----|------|------------------------|
| 1 | EGY | IBRAHIM Ayed |
| 2 | TUN | AYARI Ali |
| 3 | GBS | INTIPE Quintino |
| 3 | ALG | BOUDRAA Mohamed |
| 5 | MAR | SARDY Yassine |
| 5 | SEN | DIATTA Nicola |
| 7 | CMR | FOKAM William Celestin |
| 8 | CHA | MADJIADOU Kasimir |
| 9 | CGO | NGOUEMA Victor |

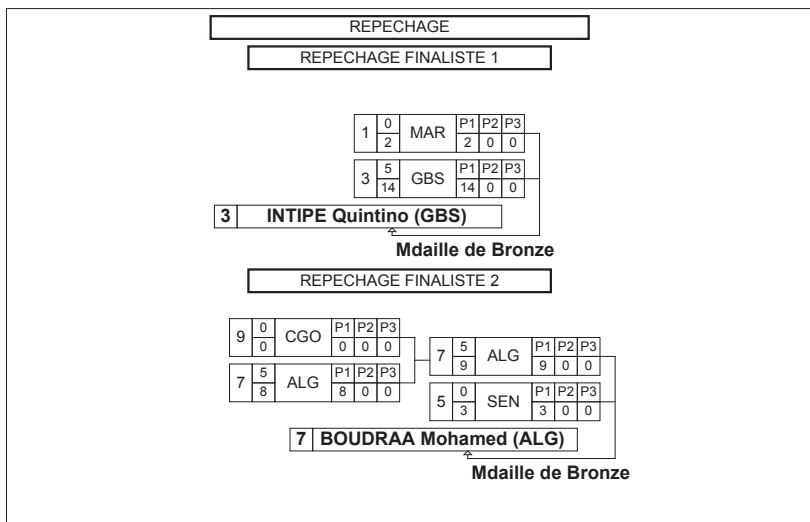



Classement

African Championship Senior

STYLE : FS 70 kg



1 - Or / Gold



IBRAHIM Ayed

2 - Argent / Silver



AYARI Ali

3 - Bronze



INTIPE Quintino



BOUDRAA Mohamed

| <i>Classement</i> | <i>Nom - Name</i> | <i>Pays - Country</i> |
|-------------------|--------------------|-----------------------|
| 1 | IBRAHIM Ayed | EGY |
| 2 | AYARI Ali | TUN |
| 3 | INTIPE Quintino | GBS |
| 3 | BOUDRAA Mohamed | ALG |
| 5 | SARDY Yassine | MAR |
| 5 | DIATTA Nicola | SEN |
| 7 | FOKAM W. | CMR |
| 8 | MADJIADOUM Kasimir | CHA |
| 9 | NGOUEMA Victor | CGO |



Feuille de compétition / Competition Sheet

African Championship Senior



STYLE : FS 74 kg

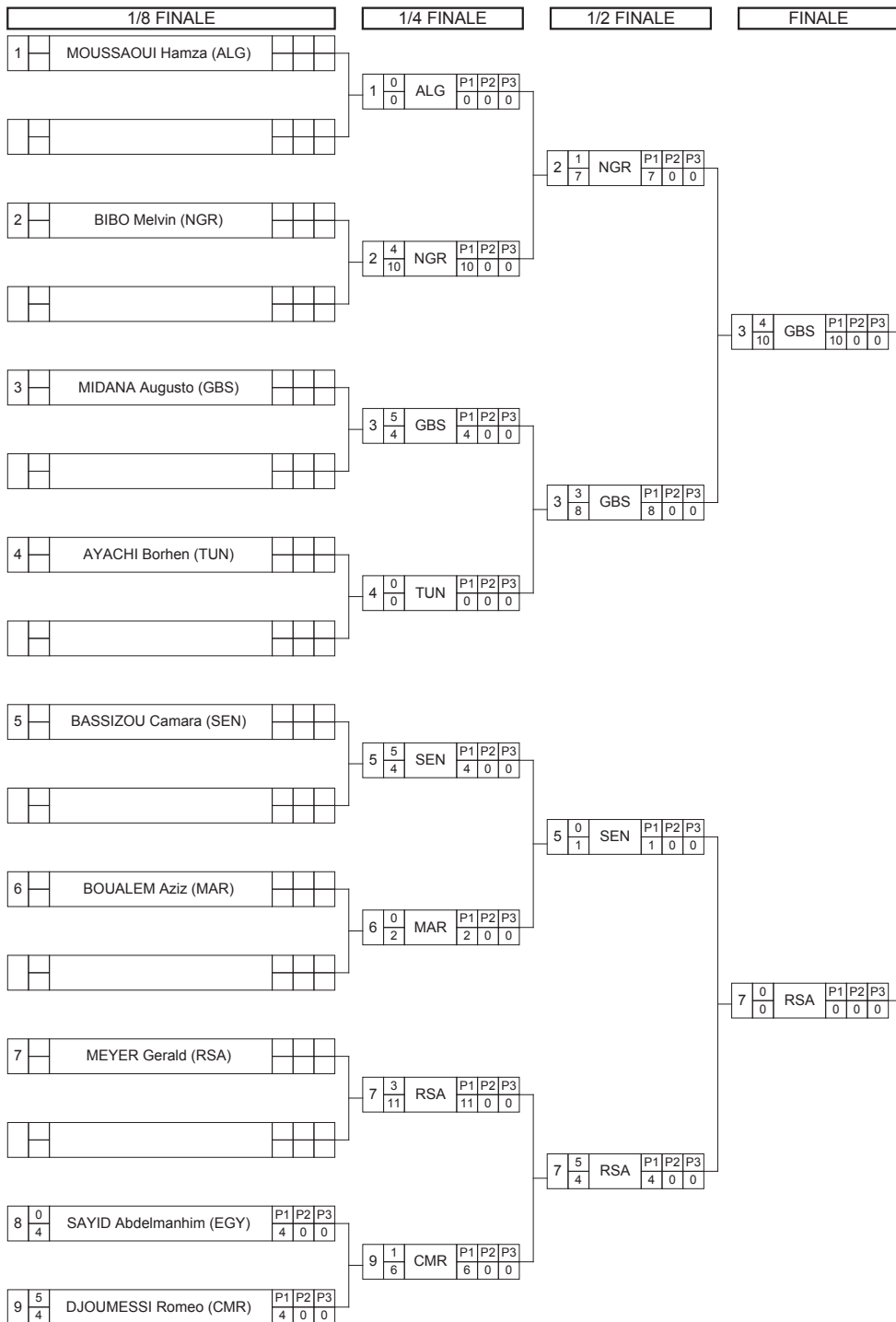

Classement

| Cl | Pays | Nom |
|----|------|-------------------|
| 1 | GBS | MIDANA Augusto |
| 2 | RSA | MEYER Gerald |
| 3 | TUN | AYACHI Borhen |
| 3 | SEN | BASSIZOU Camara |
| 5 | NGR | BIBO Melvin |
| 5 | CMR | DJOUMESSI Romeo |
| 7 | EGY | SAYID Abdelmanhim |
| 8 | MAR | BOUALEM Aziz |
| 9 | ALG | MOUSSAOUI Hamza |

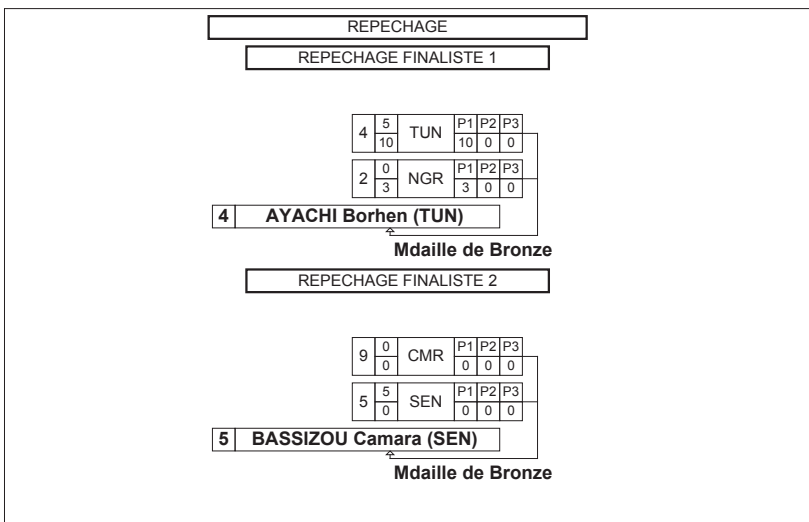



Classement

African Championship Senior

STYLE : FS 74 kg



1 - Or / Gold



MIDANA Augusto

2 - Argent / Silver



MEYER Gerald

3 - Bronze



AYACHI Borhen



BASSIZOU Camara

| <i>Classement</i> | <i>Nom - Name</i> | <i>Pays - Country</i> |
|-------------------|-------------------|-----------------------|
| 1 | MIDANA Augusto | GBS |
| 2 | MEYER Gerald | RSA |
| 3 | AYACHI Borhen | TUN |
| 3 | BASSIZOU Camara | SEN |
| 5 | BIBO Melvin | NGR |
| 5 | DJOUMESSI Romeo | CMR |
| 7 | SAYID Abdelmanhim | EGY |
| 8 | BOUALEM Aziz | MAR |
| 9 | MOUSSAOUI Hamza | ALG |



Feuille de compétition / Competition Sheet

African Championship Senior

STYLE : FS 86 kg

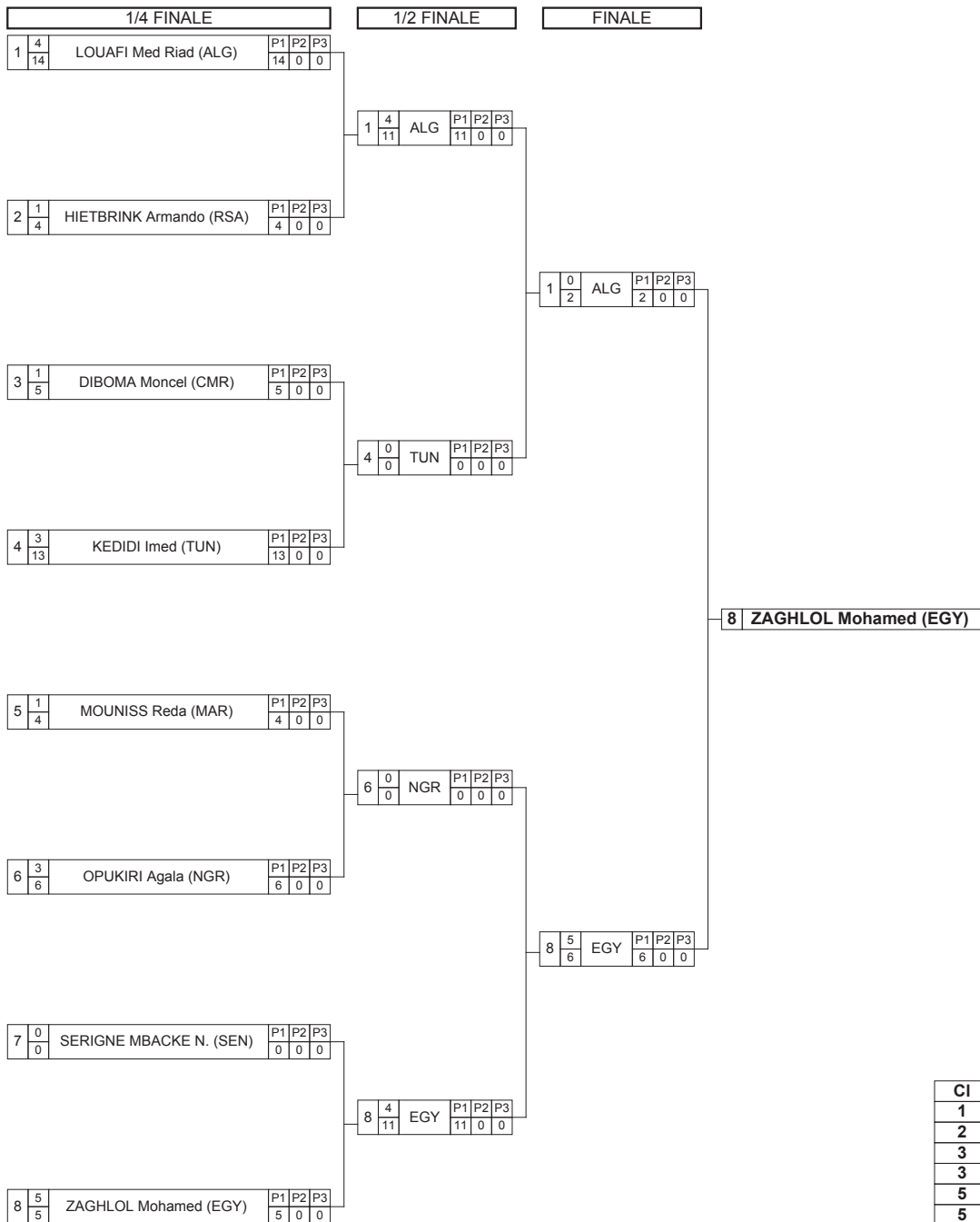
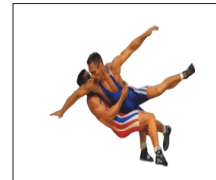

Classement

| Cl | Pays | Nom |
|----|------|---------------------|
| 1 | EGY | ZAGHLOL Mohamed |
| 2 | ALG | LOUAFI Med Riad |
| 3 | RSA | HIETBRINK Armando |
| 3 | NGR | OPUKIRI Agala |
| 5 | TUN | KEDIDI Imed |
| 5 | SEN | SERIGNE MBACKE Ngom |
| 7 | CMR | DIBOMA Moncel |
| 8 | MAR | MOUNISS Reda |

REPECHAGE

REPECHAGE FINALISTE 1

| | | | | | |
|---|----|-----|----|----|----|
| 2 | 4 | RSA | P1 | P2 | P3 |
| | 10 | | 10 | 0 | 0 |
| 4 | 1 | TUN | P1 | P2 | P3 |
| | 2 | | 2 | 0 | 0 |

2 | HIETBRINK Armando (RSA)

Mdaille de Bronze

REPECHAGE FINALISTE 2

| | | | | | |
|---|----|-----|----|----|----|
| 7 | 1 | SEN | P1 | P2 | P3 |
| | 10 | | 10 | 0 | 0 |
| 6 | 3 | NGR | P1 | P2 | P3 |
| | 10 | | 10 | 0 | 0 |

6 | OPUKIRI Agala (NGR)

Mdaille de Bronze



Classement

African Championship Senior

STYLE : FS 86 kg



1 - Or / Gold



ZAGHLOL Mohamed

2 - Argent / Silver



LOUAFI Med Riad

3 - Bronze



HIETBRINK Armando



OPUKIRI Agala

| Classement | Nom - Name | Pays - Country |
|------------|---------------------|----------------|
| 1 | ZAGHLOL Mohamed | EGY |
| 2 | LOUAFI Med Riad | ALG |
| 3 | HIETBRINK Armando | RSA |
| 3 | OPUKIRI Agala | NGR |
| 5 | KEDIDI Imed | TUN |
| 5 | SERIGNE MBACKE Ngom | SEN |
| 7 | DIBOMA Moncel | CMR |
| 8 | MOUNISS Reda | MAR |



Feuille de compétition / Competition Sheet

African Championship Senior

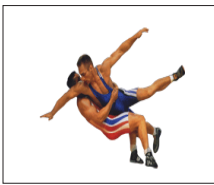

STYLE : FS 97 kg

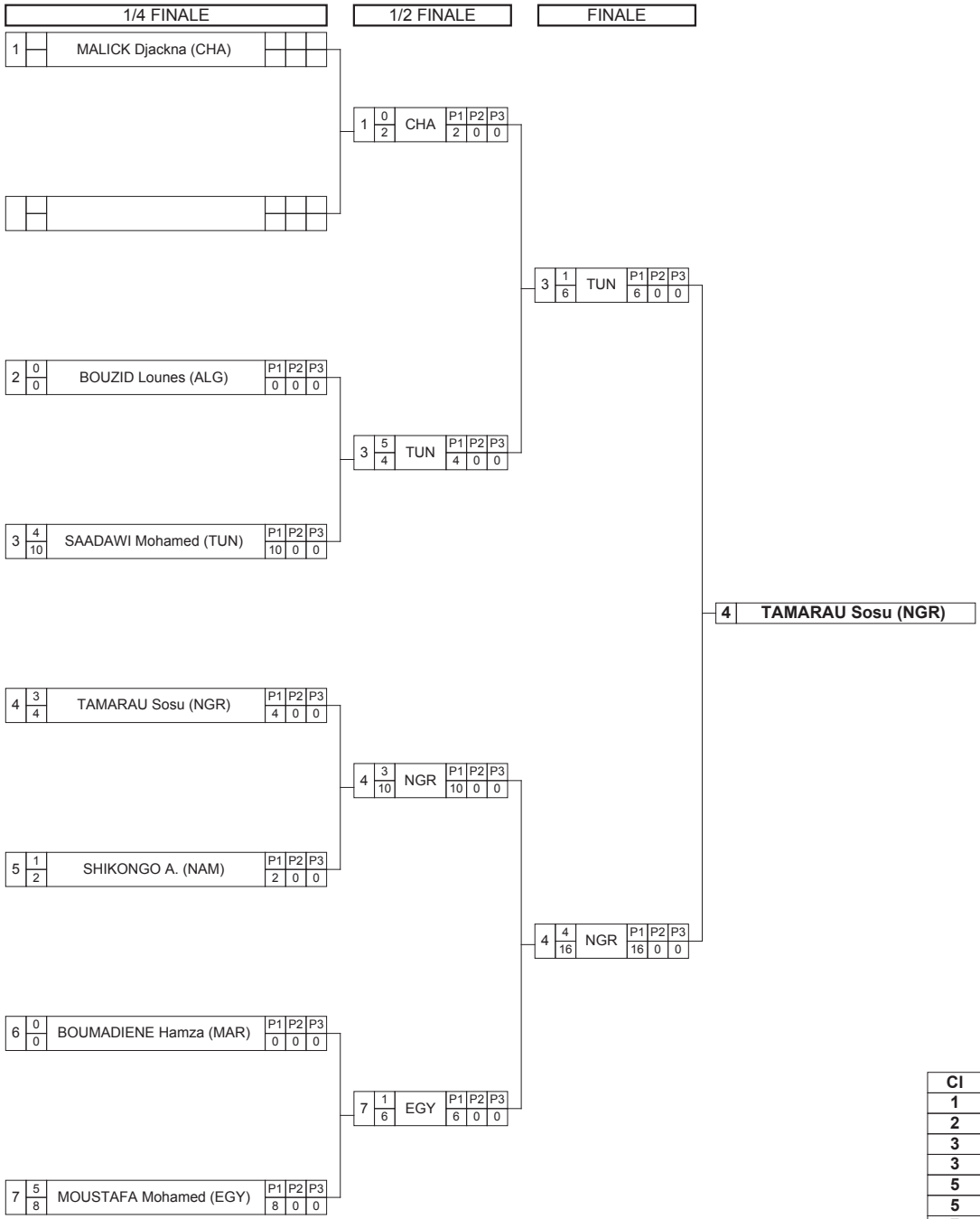

Classement

| Cl | Pays | Nom |
|----|------|------------------------|
| 1 | NGR | TAMARAU Sosu |
| 2 | TUN | SAADAWI Mohamed |
| 3 | ALG | BOUZID Lounes |
| 3 | NAM | SHIKONGO Angola Mateus |
| 5 | CHA | MALICK Djackna |
| 5 | EGY | MOUSTAFI Mohamed |
| 7 | MAR | BOUMADIENE Hamza |

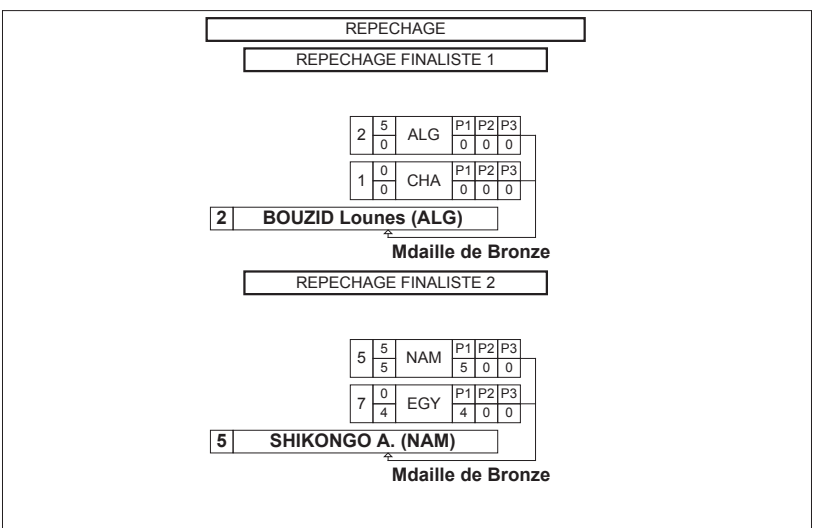



Classement

African Championship Senior

STYLE : FS 97 kg



1 - Or / Gold



TAMARAU Sosu

2 - Argent / Silver



SAADAWI Mohamed

3 - Bronze



BOUZID Lounes



SHIKONGO Angola Mateus

| <i>Classement</i> | <i>Nom - Name</i> | <i>Pays - Country</i> |
|-------------------|-------------------|-----------------------|
| 1 | TAMARAU Sosu | NGR |
| 2 | SAADAWI Mohamed | TUN |
| 3 | BOUZID Lounes | ALG |
| 3 | SHIKONGO A. | NAM |
| 5 | MALICK Djackna | CHA |
| 5 | MOUSTAFA Mohamed | EGY |
| 7 | BOUMADIENE Hamza | MAR |

**Classement par équipe / Teams ranking****African Championship Senior**

STYLE FS



| Rang | Equipe | 125 KG | 57 KG | 61 KG | 65 KG | 70 KG | 74 KG | 86 KG | 97 KG | TOTAL |
|-------------|---------------|---------------|--------------|--------------|--------------|--------------|--------------|--------------|--------------|--------------|
| 1 | TUN | 10 | 8 | 9 | 8 | 9 | 8 | 6 | 9 | 67 |
| 2 | EGY | 9 | | 8 | 6 | 10 | 4 | 10 | 6 | 53 |
| 3 | NGR | 8 | 10 | 6 | 3 | | 6 | 8 | 10 | 51 |
| 4 | ALG | | 9 | 4 | 10 | 8 | 2 | 9 | 8 | 50 |
| 5 | SEN | 8 | | 10 | | 6 | 8 | 6 | | 38 |
| 6 | MAR | 4 | 6 | 6 | 6 | 6 | 3 | 3 | 4 | 38 |
| 7 | CMR | 5 | 8 | | 8 | 4 | 6 | 4 | | 35 |
| 8 | RSA | | | 8 | 2 | | 9 | 8 | | 27 |
| 9 | CHA | 6 | 3 | 2 | 1 | 3 | | | 6 | 21 |
| 10 | GBS | | | | | 8 | 10 | | | 18 |
| 11 | CGO | | 6 | | 4 | 2 | | | | 12 |
| 12 | NAM | | | 3 | | | | | 8 | 11 |
| 13 | MAD | | | | 9 | | | | | 9 |
| 14 | MRI | | 4 | | | | | | | 4 |

AFRICAN CHAMPIONSHIP SENIOR



TUNIS (TUN)

2014-03-28 - 2014-03-30 2014

Résultats - Results

Lutte Féminine - Female-Wrestling



**Liste des arbitres / Referee list****African Championship Senior**

| N° | Licence | Pays Country | Nom - Last Name | Prénom - First Name |
|-----------|----------------|-------------------------|------------------------|----------------------------|
| | | ALG | DOGHDOGH | Hamza |
| | | ALG | FETIAR | Riadh |
| | | ALG | MERDADI | Faouzi |
| | | ALG | NAANAA | Yacine |
| | | ALG | SIGUERDJDJENE | Omar |
| | | ALG | TRAI | Belcacem |
| | | EGY | AHMAD ZAKI | Salman |
| | | EGY | HALAWA | Cherif Ali |
| | | EGY | MOHAMED | Etman |
| | | JOR | MAHMOUD | Alaziz |
| | | JOR | MUNIERAL | Sallaq |
| | | JOR | NAIEF | Aloush |
| | | MAR | ZAIMI | Abdallah |
| | | NGR | USMAN | Yusuf |
| | | SAM | CHARLE | Vallet |
| | | SEN | NGOM | Malik |
| | | TUN | BOUSLAHI | Mohamed |
| | | TUN | KHARAZI | Jamel |
| | | TUN | MANAI | Hedi |
| | | TUN | ZERMDINI | Tayeb |

Nombre d'arbitres - Number of Referee

20



Liste des nations / Countries List

African Championship Senior

STYLE FW



Pays - Country











| | | |
|---|---------------|-----|
|  | CAMEROON | CMR |
|  | CHAD | CHA |
|  | CONGO | CGO |
|  | COTE D'IVOIRE | CIV |
|  | EGYPT | EGY |
|  | GUINEA-BISSAU | GBS |
|  | NIGERIA | NGR |
|  | SENEGAL | SEN |
|  | SIERRA LEONE | SLE |
|  | SOUTH AFRICA | RSA |
|  | TUNISIA | TUN |

Nombre de nations - Number of Countries

**Nombre d'engagés par nation / Number of Entries By Country****African Championship Senior**

STYLE FW



| Pays - Country | 48 KG | 53 KG | 55 KG | 58 KG | 60 KG | 63 KG | 69 KG | 75 KG | TOTAL |
|---|--------------|--------------|--------------|--------------|--------------|--------------|--------------|--------------|--------------|
|  CGO | | | | 1 | | | | | 1 |
|  CHA | | | | 1 | | 1 | 1 | 1 | 4 |
|  CIV | 1 | | | | | | | | 1 |
|  CMR | 1 | | 1 | 1 | | 1 | 1 | 1 | 6 |
|  EGY | | | | | | | 1 | 1 | 2 |
|  GBS | | | | | | 1 | | | 1 |
|  NGR | 1 | 1 | 1 | 1 | 1 | 1 | 1 | 1 | 8 |
|  RSA | | | 1 | 1 | | 1 | | | 3 |
|  SEN | 1 | 1 | | 1 | 1 | 1 | | | 5 |
|  SLE | | | | | | | | 1 | 1 |
|  TUN | 1 | 1 | 1 | 1 | 1 | 1 | 1 | 1 | 8 |
| TOTAL | 5 | 3 | 4 | 7 | 3 | 7 | 5 | 6 | 40 |

Nombre de nations - Number of Countries **11**



Liste des Engagés par pays / Entry-List By Country

African Championship Senior

STYLE FW

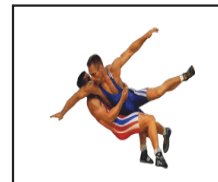

CAMEROON (CMR)

Lutteuse(s) / Wrestler(s) :

| | |
|-------|-------------------------|
| 48 kg | MUAMBO, Ndolo Rebeca |
| 55 kg | ESSOMBE TIAKO, Joseph |
| 58 kg | NGONO EYIA, Ednige |
| 63 kg | METALA EPANGA, Blandine |
| 69 kg | TOMO ANGELE, Pascaline |
| 75 kg | ALI ANABEL, Laure |

CHAD (CHA)

Lutteuse(s) / Wrestler(s) :

| | |
|-------|---------------------|
| 58 kg | HAOUA, Hackna |
| 63 kg | AISSATOU, Rosine |
| 69 kg | MEMNELOUM, Clarisse |
| 75 kg | FATIME, Harouni |

CONGO (CGO)

Lutteuse(s) / Wrestler(s) :

| | |
|-------|------------------|
| 58 kg | MAMBOU, Parfaite |
|-------|------------------|

COTE D'IVOIRE (CIV)

Lutteuse(s) / Wrestler(s) :

| | |
|-------|-----------------------|
| 48 kg | BEIVIE TANDH, Rozalie |
|-------|-----------------------|

EGYPT (EGY)

Lutteuse(s) / Wrestler(s) :

| | |
|-------|------------------------|
| 69 kg | MOUSTAFA, Enas Youssef |
| 75 kg | ANTER YACINE, Nadia |

GUINEA-BISSAU (GBS)

Lutteuse(s) / Wrestler(s) :

| | |
|-------|----------------------------|
| 63 kg | MENDONKA, Jasipa Francicko |
|-------|----------------------------|

NIGERIA (NGR)



Liste des Engagés par pays / Entry-List By Country

African Championship Senior

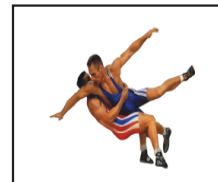

STYLE FW

Lutteuse(s) / Wrestler(s) :

| | |
|-------|-----------------------------|
| 48 kg | SAMMY, Ozita |
| 53 kg | ADEKUROYE, Odunayo Folasade |
| 55 kg | BISOLA, Makanjuola |
| 58 kg | OPUENE, Patience |
| 60 kg | ADEMIYI, Amimat |
| 63 kg | OBORUDUDU, Blessing |
| 69 kg | IHEANACITO, Ifeoma |
| 75 kg | AM ESTHER, Gyan |

SENEGAL (SEN)

Lutteuse(s) / Wrestler(s) :

| | |
|-------|--------------------|
| 48 kg | SAMBOU, Nahamy |
| 53 kg | SAMBOU, Isabelle |
| 58 kg | GOUDIABY, Safietou |
| 60 kg | SAMBOU, Anta |
| 63 kg | SENGHOR, Binta |

SIERRA LEONE (SLE)

Lutteuse(s) / Wrestler(s) :

| | |
|-------|------------------|
| 75 kg | HAJARATU, Kamara |
|-------|------------------|

SOUTH AFRICA (RSA)

Lutteuse(s) / Wrestler(s) :

| | |
|-------|-------------------|
| 55 kg | MADI, Mpho |
| 58 kg | COESTER, Jeannie |
| 63 kg | GERINGER, Zumicke |

TUNISIA (TUN)

Lutteuse(s) / Wrestler(s) :

| | |
|-------|-----------------|
| 48 kg | MIZIENI, Marwa |
| 53 kg | JEMAI, Salma |
| 55 kg | AMRI, Marwa |
| 58 kg | RIEBI, Hela |
| 60 kg | AYARI, Rim |
| 63 kg | AISSEWI, Sirine |



Liste des Engagés par pays / Entry-List By Country

African Championship Senior

STYLE FW

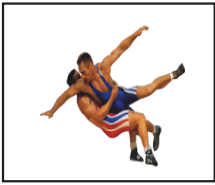

69 kg

TRABELSI, Wiem

75 kg

FATHALAH, Mariem



Feuille de compétition / Competition Sheet

African Championship Senior

STYLE : FW 48 kg



TOUR : 1

| | | | | | | | |
|---|---------|-----------------------|----------|---------|---------|-----|---------------------|
| 1 | 1 3 | SAMMY Ozita (NGR) | P1 3 | P2 0 | P3 0 | } 2 | MUAMBO N. (CMR) |
| 2 | 3 8 | MUAMBO N. (CMR) | P1 8 | P2 0 | P3 0 | | |
| 3 | 4 12 | SAMBOU Nahamy (SEN) | P1 12 | P2 0 | P3 0 | } 3 | SAMBOU Nahamy (SEN) |
| 4 | 0 0 | BEIVIE TANDH R. (CIV) | P1 0 | P2 0 | P3 0 | | |

TOUR : 2

| | | | | | | | |
|---|---------|---------------------|----------|---------|---------|-----|---------------------|
| 5 | 4 10 | MIZIENI Marwa (TUN) | P1 10 | P2 0 | P3 0 | } 5 | MIZIENI Marwa (TUN) |
| 1 | 0 1 | SAMMY Ozita (NGR) | P1 1 | P2 0 | P3 0 | | |
| 2 | 3 9 | MUAMBO N. (CMR) | P1 9 | P2 0 | P3 0 | } 2 | MUAMBO N. (CMR) |
| 3 | 1 4 | SAMBOU Nahamy (SEN) | P1 4 | P2 0 | P3 0 | | |

TOUR : 3

| | | | | | | | |
|---|---------|-----------------------|----------|---------|---------|-----|---------------------|
| 4 | 0 0 | BEIVIE TANDH R. (CIV) | P1 0 | P2 0 | P3 0 | } 1 | SAMMY Ozita (NGR) |
| 1 | 4 10 | SAMMY Ozita (NGR) | P1 10 | P2 0 | P3 0 | | |
| 5 | 4 11 | MIZIENI Marwa (TUN) | P1 11 | P2 0 | P3 0 | } 5 | MIZIENI Marwa (TUN) |
| 2 | 0 6 | MUAMBO N. (CMR) | P1 6 | P2 0 | P3 0 | | |

TOUR : 4

| | | | | | | | |
|---|--------|-----------------------|---------|---------|---------|-----|---------------------|
| 3 | 4 4 | SAMBOU Nahamy (SEN) | P1 4 | P2 0 | P3 0 | } 3 | SAMBOU Nahamy (SEN) |
| 1 | 0 0 | SAMMY Ozita (NGR) | P1 0 | P2 0 | P3 0 | | |
| 4 | 0 0 | BEIVIE TANDH R. (CIV) | P1 0 | P2 0 | P3 0 | } 5 | MIZIENI Marwa (TUN) |
| 5 | 4 8 | MIZIENI Marwa (TUN) | P1 8 | P2 0 | P3 0 | | |

TOUR : 5

| | | | | | | | |
|---|---------|-----------------------|----------|---------|---------|-----|---------------------|
| 2 | 4 10 | MUAMBO N. (CMR) | P1 10 | P2 0 | P3 0 | } 2 | MUAMBO N. (CMR) |
| 4 | 0 0 | BEIVIE TANDH R. (CIV) | P1 0 | P2 0 | P3 0 | | |
| 3 | 1 3 | SAMBOU Nahamy (SEN) | P1 3 | P2 0 | P3 0 | } 5 | MIZIENI Marwa (TUN) |
| 5 | 3 5 | MIZIENI Marwa (TUN) | P1 5 | P2 0 | P3 0 | | |

Classement

| Cl | Pays | Nom | Points |
|----|------|---------------------|--------|
| 1 | TUN | MIZIENI Marwa | 15 |
| 2 | CMR | MUAMBO Ndolo Rebeca | 10 |
| 3 | SEN | SAMBOU Nahamy | 10 |
| 4 | NGR | SAMMY Ozita | 5 |
| 5 | CIV | BEIVIE TANDH R. | 0 |



Classement

African Championship Senior

STYLE : FW 48 kg



1 - Or / Gold



MIZIENI Marwa

2 - Argent / Silver



MUAMBO Ndolo Rebeca

3 - Bronze



SAMBOU Nahamy

| Classement | Nom - Name | Pays - Country | Points |
|------------|---------------------|----------------|--------|
| 1 | MIZIENI Marwa | TUN | 15 |
| 2 | MUAMBO Ndolo Rebeca | CMR | 10 |
| 3 | SAMBOU Nahamy | SEN | 10 |
| 4 | SAMMY Ozita | NGR | 5 |
| 5 | BEIVIE TANDH R. | CIV | 0 |



Feuille de compétition / Competition Sheet

African Championship Senior

STYLE : FW 53 kg



TOUR : 1

| | | | | | | | |
|---|---------------|-----------------------|----|----|----|---|-----------------------|
| 1 | $\frac{1}{2}$ | JEMAI Salma (TUN) | P1 | P2 | P3 | 2 | SAMBOU Isabelle (SEN) |
| | | | 2 | 0 | 0 | | |
| 2 | $\frac{3}{7}$ | SAMBOU Isabelle (SEN) | P1 | P2 | P3 | | |
| | | | 7 | 0 | 0 | | |

TOUR : 2

| | | | | | | | |
|---|---------------|--------------------|----|----|----|---|--------------------|
| 3 | $\frac{4}{8}$ | ADEKUROYE O. (NGR) | P1 | P2 | P3 | 3 | ADEKUROYE O. (NGR) |
| | | | 8 | 0 | 0 | | |
| 1 | $\frac{0}{0}$ | JEMAI Salma (TUN) | P1 | P2 | P3 | | |
| | | | 0 | 0 | 0 | | |

TOUR : 3

| | | | | | | | |
|---|---------------|-----------------------|----|----|----|---|-----------------------|
| 2 | $\frac{3}{5}$ | SAMBOU Isabelle (SEN) | P1 | P2 | P3 | 2 | SAMBOU Isabelle (SEN) |
| | | | 5 | 0 | 0 | | |
| 3 | $\frac{1}{4}$ | ADEKUROYE O. (NGR) | P1 | P2 | P3 | | |
| | | | 4 | 0 | 0 | | |

Classement

| Cl | Pays | Nom | Points |
|----|------|-----------------|--------|
| 1 | SEN | SAMBOU Isabelle | 6 |
| 2 | NGR | ADEKUROYE O. | 5 |
| 3 | TUN | JEMAI Salma | 1 |



Classement

African Championship Senior

STYLE : FW 53 kg



1 - Or / Gold



SAMBOU Isabelle

2 - Argent / Silver



ADEKUROYE Odunayo Folasade

3 - Bronze



JEMAI Salma

| <i>Classement</i> | <i>Nom - Name</i> | <i>Pays - Country</i> | <i>Points</i> |
|-------------------|-------------------|-----------------------|---------------|
| 1 | SAMBOU Isabelle | SEN | 6 |
| 2 | ADEKUROYE O. | NGR | 5 |
| 3 | JEMAI Salma | TUN | 1 |



Feuille de compétition / Competition Sheet

African Championship Senior

STYLE : FW 55 kg



TOUR : 1

| | | | | | | | |
|---|---------------|-------------------------|----|----|----|-----|-------------------------|
| 1 | $\frac{0}{0}$ | ESSOMBE TIAKO J. (CMR) | P1 | P2 | P3 | } 2 | AMRI Marwa (TUN) |
| | | | 0 | 0 | 0 | | |
| 2 | $\frac{4}{4}$ | AMRI Marwa (TUN) | P1 | P2 | P3 | | |
| | | | 4 | 0 | 0 | | |
| 3 | $\frac{4}{6}$ | BISOLA Makanjuola (NGR) | P1 | P2 | P3 | } 3 | BISOLA Makanjuola (NGR) |
| | | | 6 | 0 | 0 | | |
| 4 | $\frac{0}{0}$ | MADI Mpho (RSA) | P1 | P2 | P3 | | |
| | | | 0 | 0 | 0 | | |

TOUR : 2

| | | | | | | | |
|---|---------------|-------------------------|----|----|----|-----|-------------------------|
| 1 | $\frac{1}{5}$ | ESSOMBE TIAKO J. (CMR) | P1 | P2 | P3 | } 3 | BISOLA Makanjuola (NGR) |
| | | | 5 | 0 | 0 | | |
| 3 | $\frac{3}{8}$ | BISOLA Makanjuola (NGR) | P1 | P2 | P3 | | |
| | | | 8 | 0 | 0 | | |
| 2 | $\frac{4}{6}$ | AMRI Marwa (TUN) | P1 | P2 | P3 | } 2 | AMRI Marwa (TUN) |
| | | | 6 | 0 | 0 | | |
| 4 | $\frac{0}{0}$ | MADI Mpho (RSA) | P1 | P2 | P3 | | |
| | | | 0 | 0 | 0 | | |

TOUR : 3

| | | | | | | | |
|---|----------------|-------------------------|----|----|----|-----|------------------------|
| 1 | $\frac{3}{11}$ | ESSOMBE TIAKO J. (CMR) | P1 | P2 | P3 | } 1 | ESSOMBE TIAKO J. (CMR) |
| | | | 11 | 0 | 0 | | |
| 4 | $\frac{1}{10}$ | MADI Mpho (RSA) | P1 | P2 | P3 | | |
| | | | 10 | 0 | 0 | | |
| 2 | $\frac{4}{5}$ | AMRI Marwa (TUN) | P1 | P2 | P3 | } 2 | AMRI Marwa (TUN) |
| | | | 5 | 0 | 0 | | |
| 3 | $\frac{0}{0}$ | BISOLA Makanjuola (NGR) | P1 | P2 | P3 | | |
| | | | 0 | 0 | 0 | | |

Classement

| Cl | Pays | Nom | Points |
|----|------|-------------------|--------|
| 1 | TUN | AMRI Marwa | 12 |
| 2 | NGR | BISOLA Makanjuola | 7 |
| 3 | CMR | ESSOMBE TIAKO J. | 4 |
| 4 | RSA | MADI Mpho | 1 |



Classement

African Championship Senior

STYLE : FW 55 kg



1 - Or / Gold



AMRI Marwa

2 - Argent / Silver



BISOLA Makanjuola

3 - Bronze



ESSOMBE TIAKO Joseph

| <i>Classement</i> | <i>Nom - Name</i> | <i>Pays - Country</i> | <i>Points</i> |
|-------------------|-------------------|-----------------------|---------------|
| 1 | AMRI Marwa | TUN | 12 |
| 2 | BISOLA Makanjuola | NGR | 7 |
| 3 | ESSOMBE TIAKO J. | CMR | 4 |
| 4 | MADI Mpho | RSA | 1 |



Feuille de compétition / Competition Sheet

African Championship Senior



STYLE : FW 58 kg

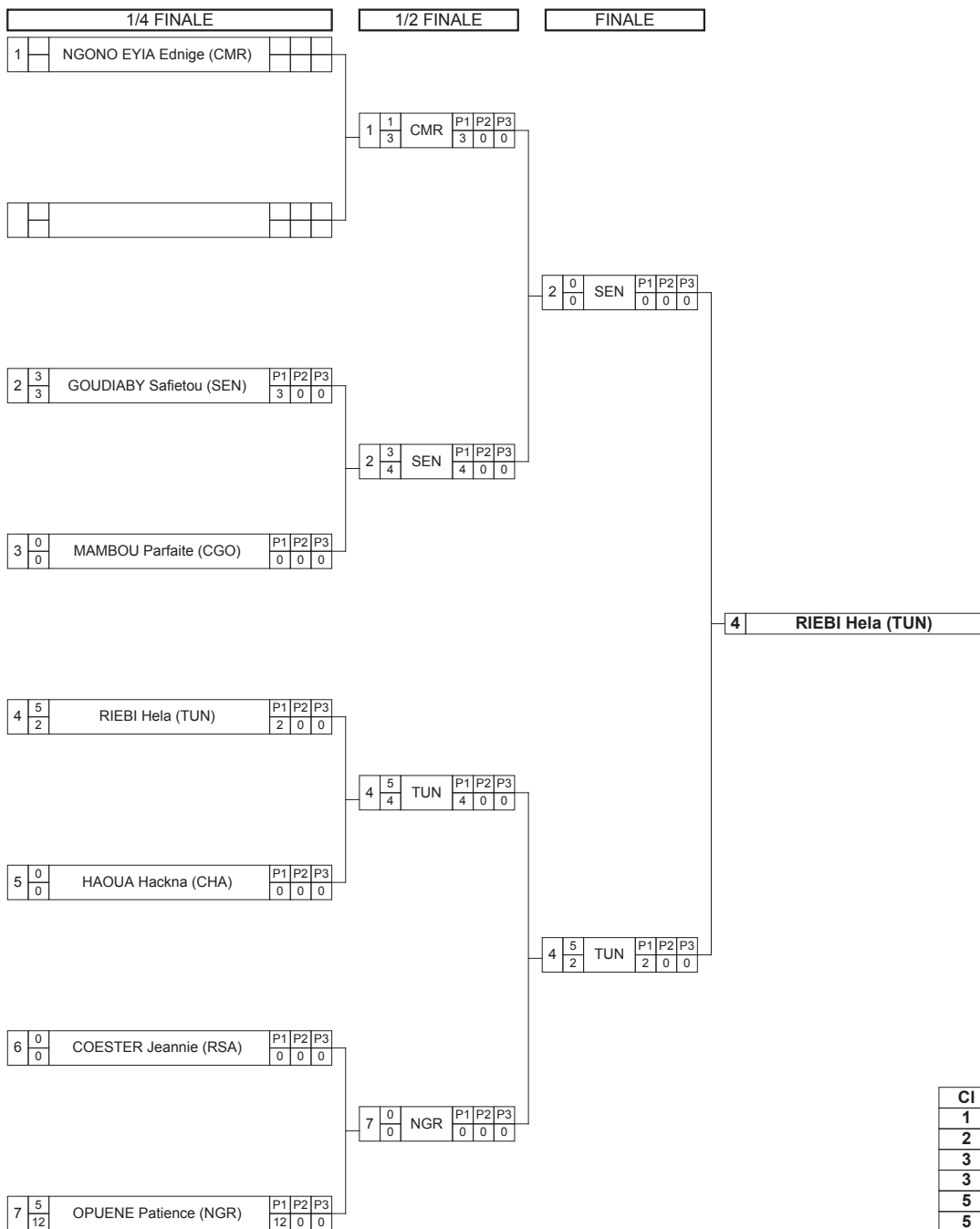

Classement

| Cl | Pays | Nom |
|----|------|-------------------|
| 1 | TUN | RIEBI Hela |
| 2 | SEN | GOUDIABY Safietou |
| 3 | NGR | OPUENE Patience |
| 3 | CMR | NGONO EYIA Ednige |
| 5 | CHA | HAOUA Hackna |
| 5 | CGO | MAMBOU Parfaite |
| 7 | RSA | COESTER Jeannie |

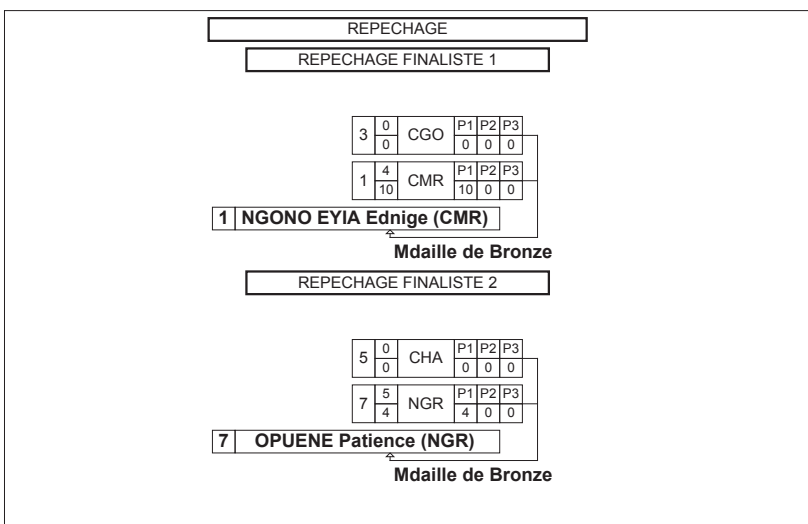



Classement

African Championship Senior

STYLE : FW 58 kg



1 - Or / Gold



RIEBI Hela

2 - Argent / Silver



GOUDIABY Safietou

3 - Bronze



OPUENE Patience



NGONO EYIA Ednige

| <i>Classement</i> | <i>Nom - Name</i> | <i>Pays - Country</i> |
|-------------------|-------------------|-----------------------|
| 1 | RIEBI Hela | TUN |
| 2 | GOUDIABY Safietou | SEN |
| 3 | OPUENE Patience | NGR |
| 3 | NGONO EYIA Ednige | CMR |
| 5 | HAOUA Hackna | CHA |
| 5 | MAMBOU Parfaite | CGO |
| 7 | COESTER Jeannie | RSA |



Feuille de compétition / Competition Sheet

African Championship Senior

STYLE : FW 60 kg



TOUR : 1

| | | | | | | | |
|---|---------|-------------------|---------|---------|---------|---|-------------------|
| 1 | 0 8 | AYARI Rim (TUN) | P1 8 | P2 0 | P3 0 | 2 | SAMBOU Anta (SEN) |
| 2 | 4 14 | SAMBOU Anta (SEN) | P1 6 | P2 8 | P3 0 | | |

TOUR : 2

| | | | | | | | |
|---|---------|----------------------|----------|---------|---------|---|----------------------|
| 3 | 4 13 | ADEMIYI Amimat (NGR) | P1 13 | P2 0 | P3 0 | 3 | ADEMIYI Amimat (NGR) |
| 1 | 1 2 | AYARI Rim (TUN) | P1 2 | P2 0 | P3 0 | | |

TOUR : 3

| | | | | | | | |
|---|---------|----------------------|----------|---------|---------|---|----------------------|
| 2 | 1 2 | SAMBOU Anta (SEN) | P1 2 | P2 0 | P3 0 | 3 | ADEMIYI Amimat (NGR) |
| 3 | 3 10 | ADEMIYI Amimat (NGR) | P1 10 | P2 0 | P3 0 | | |

Classement

| Cl | Pays | Nom | Points |
|----|------|----------------|--------|
| 1 | NGR | ADEMIYI Amimat | 7 |
| 2 | SEN | SAMBOU Anta | 5 |
| 3 | TUN | AYARI Rim | 1 |



Classement

African Championship Senior

STYLE : FW 60 kg



1 - Or / Gold



ADEMIYI Amimat

2 - Argent / Silver



SAMBOU Anta

3 - Bronze



AYARI Rim

| <i>Classement</i> | <i>Nom - Name</i> | <i>Pays - Country</i> | <i>Points</i> |
|-------------------|-------------------|-----------------------|---------------|
| 1 | ADEMIYI Amimat | NGR | 7 |
| 2 | SAMBOU Anta | SEN | 5 |
| 3 | AYARI Rim | TUN | 1 |



Feuille de compétition / Competition Sheet

African Championship Senior



STYLE : FW 63 kg

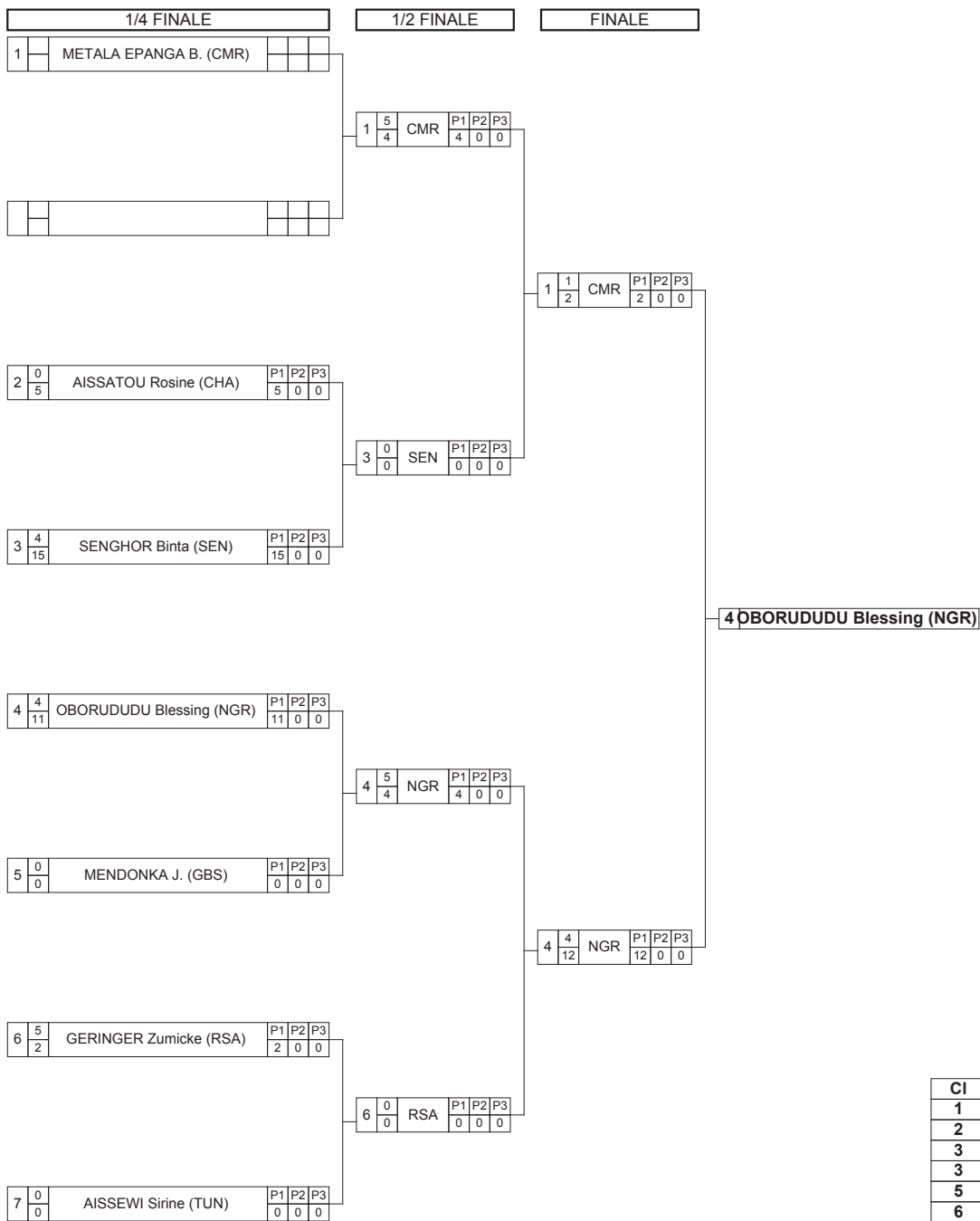

Classement

| Cl | Pays | Nom |
|----|------|---------------------------|
| 1 | NGR | OBORUDUDU Blessing |
| 2 | CMR | METALA EPANGA Blandine |
| 3 | GBS | MENDONKA Jasipa Francicko |
| 3 | SEN | SENGHOR Binta |
| 5 | RSA | GERINGER Zumicke |
| 6 | CHA | AISSATOU Rosine |
| 7 | TUN | AISSEWI Sirine |

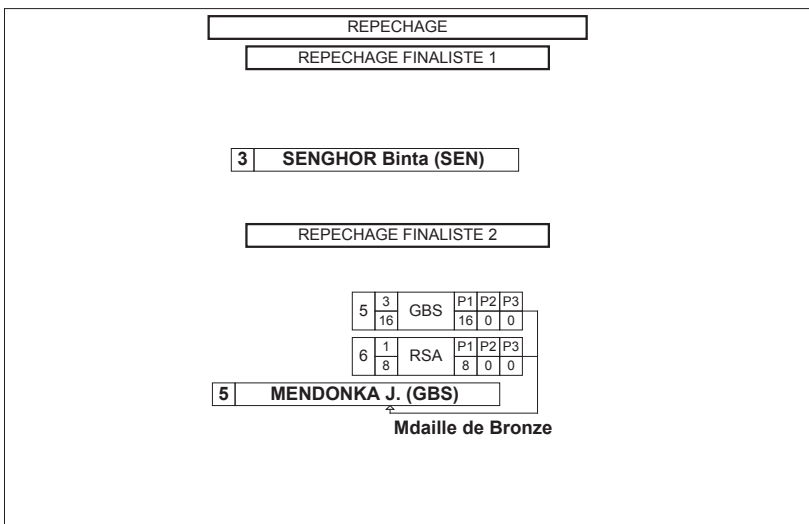



Classement

African Championship Senior

STYLE : FW 63 kg



1 - Or / Gold



OBORUDUDU Blessing

2 - Argent / Silver



METALA EPANGA Blandine

3 - Bronze



MENDONKA Jasipa Francicko



SENGHOR Binta

| <i>Classement</i> | <i>Nom - Name</i> | <i>Pays - Country</i> |
|-------------------|--------------------|-----------------------|
| 1 | OBORUDUDU Blessing | NGR |
| 2 | METALA EPANGA B. | CMR |
| 3 | MENDONKA J. | GBS |
| 3 | SENGHOR Binta | SEN |
| 5 | GERINGER Zumicke | RSA |
| 6 | AISSATOU Rosine | CHA |
| 7 | AISSEWI Sirine | TUN |



Feuille de compétition / Competition Sheet

African Championship Senior

STYLE : FW 69 kg



TOUR : 1

| | | | | | | | |
|---|----------------|--------------------------|----|----|----|---|----------------------|
| 1 | $\frac{4}{2}$ | MOUSTAFA E. (EGY) | P1 | P2 | P3 | 1 | MOUSTAFA E. (EGY) |
| | | | 2 | 0 | 0 | | |
| 2 | $\frac{0}{0}$ | TRABELSI Wiem (TUN) | P1 | P2 | P3 | 3 | TOMO ANGELE P. (CMR) |
| | | | 0 | 0 | 0 | | |
| 3 | $\frac{4}{10}$ | TOMO ANGELE P. (CMR) | P1 | P2 | P3 | 3 | TOMO ANGELE P. (CMR) |
| | | | 10 | 0 | 0 | | |
| 4 | $\frac{0}{0}$ | MEMNELOUM Clarisse (CHA) | P1 | P2 | P3 | 3 | TOMO ANGELE P. (CMR) |
| | | | 0 | 0 | 0 | | |

TOUR : 2

| | | | | | | | |
|---|---------------|-------------------------|----|----|----|---|----------------------|
| 5 | $\frac{0}{2}$ | IHEANACITO Ifeoma (NGR) | P1 | P2 | P3 | 1 | MOUSTAFA E. (EGY) |
| | | | 2 | 0 | 0 | | |
| 1 | $\frac{4}{5}$ | MOUSTAFA E. (EGY) | P1 | P2 | P3 | 3 | TOMO ANGELE P. (CMR) |
| | | | 5 | 0 | 0 | | |
| 2 | $\frac{0}{0}$ | TRABELSI Wiem (TUN) | P1 | P2 | P3 | 3 | TOMO ANGELE P. (CMR) |
| | | | 0 | 0 | 0 | | |
| 3 | $\frac{4}{6}$ | TOMO ANGELE P. (CMR) | P1 | P2 | P3 | 3 | TOMO ANGELE P. (CMR) |
| | | | 6 | 0 | 0 | | |

TOUR : 3

| | | | | | | | |
|---|----------------|--------------------------|----|----|----|---|-------------------------|
| 4 | $\frac{0}{0}$ | MEMNELOUM Clarisse (CHA) | P1 | P2 | P3 | 1 | MOUSTAFA E. (EGY) |
| | | | 0 | 0 | 0 | | |
| 1 | $\frac{3}{8}$ | MOUSTAFA E. (EGY) | P1 | P2 | P3 | 5 | IHEANACITO Ifeoma (NGR) |
| | | | 8 | 0 | 0 | | |
| 5 | $\frac{4}{10}$ | IHEANACITO Ifeoma (NGR) | P1 | P2 | P3 | 5 | IHEANACITO Ifeoma (NGR) |
| | | | 10 | 0 | 0 | | |
| 2 | $\frac{0}{0}$ | TRABELSI Wiem (TUN) | P1 | P2 | P3 | 5 | IHEANACITO Ifeoma (NGR) |
| | | | 0 | 0 | 0 | | |

TOUR : 4

| | | | | | | | |
|---|----------------|--------------------------|----|----|----|---|-------------------------|
| 3 | $\frac{0}{1}$ | TOMO ANGELE P. (CMR) | P1 | P2 | P3 | 1 | MOUSTAFA E. (EGY) |
| | | | 1 | 0 | 0 | | |
| 1 | $\frac{4}{10}$ | MOUSTAFA E. (EGY) | P1 | P2 | P3 | 5 | IHEANACITO Ifeoma (NGR) |
| | | | 10 | 0 | 0 | | |
| 4 | $\frac{0}{0}$ | MEMNELOUM Clarisse (CHA) | P1 | P2 | P3 | 5 | IHEANACITO Ifeoma (NGR) |
| | | | 0 | 0 | 0 | | |
| 5 | $\frac{4}{4}$ | IHEANACITO Ifeoma (NGR) | P1 | P2 | P3 | 5 | IHEANACITO Ifeoma (NGR) |
| | | | 4 | 0 | 0 | | |

TOUR : 5

| | | | | | | | |
|---|---------------|--------------------------|----|----|----|---|--------------------------|
| 2 | $\frac{0}{2}$ | TRABELSI Wiem (TUN) | P1 | P2 | P3 | 4 | MEMNELOUM Clarisse (CHA) |
| | | | 2 | 0 | 0 | | |
| 4 | $\frac{4}{6}$ | MEMNELOUM Clarisse (CHA) | P1 | P2 | P3 | 3 | TOMO ANGELE P. (CMR) |
| | | | 6 | 0 | 0 | | |
| 3 | $\frac{4}{2}$ | TOMO ANGELE P. (CMR) | P1 | P2 | P3 | 3 | TOMO ANGELE P. (CMR) |
| | | | 2 | 0 | 0 | | |
| 5 | $\frac{0}{0}$ | IHEANACITO Ifeoma (NGR) | P1 | P2 | P3 | 3 | TOMO ANGELE P. (CMR) |
| | | | 0 | 0 | 0 | | |

Classement

| Cl | Pays | Nom | Points |
|----|------|--------------------|--------|
| 1 | EGY | MOUSTAFA E. | 15 |
| 2 | CMR | TOMO ANGELE P. | 12 |
| 3 | NGR | IHEANACITO Ifeoma | 8 |
| 4 | CHA | MEMNELOUM Clarisse | 4 |
| 5 | TUN | TRABELSI Wiem | 0 |



Classement

African Championship Senior

STYLE : FW 69 kg



1 - Or / Gold



MOUSTAFA Enas Youssef

2 - Argent / Silver



TOMO ANGELE Pascaline

3 - Bronze



IHEANACITO Ifeoma

| Classement | Nom - Name | Pays - Country | Points |
|------------|--------------------|----------------|--------|
| 1 | MOUSTAFA E. | EGY | 15 |
| 2 | TOMO ANGELE P. | CMR | 12 |
| 3 | IHEANACITO Ifeoma | NGR | 8 |
| 4 | MEMNELOUM Clarisse | CHA | 4 |
| 5 | TRABELSI Wiem | TUN | 0 |



Feuille de compétition / Competition Sheet

African Championship Senior

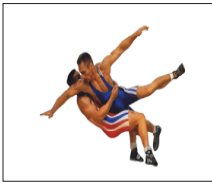

STYLE : FW 75 kg

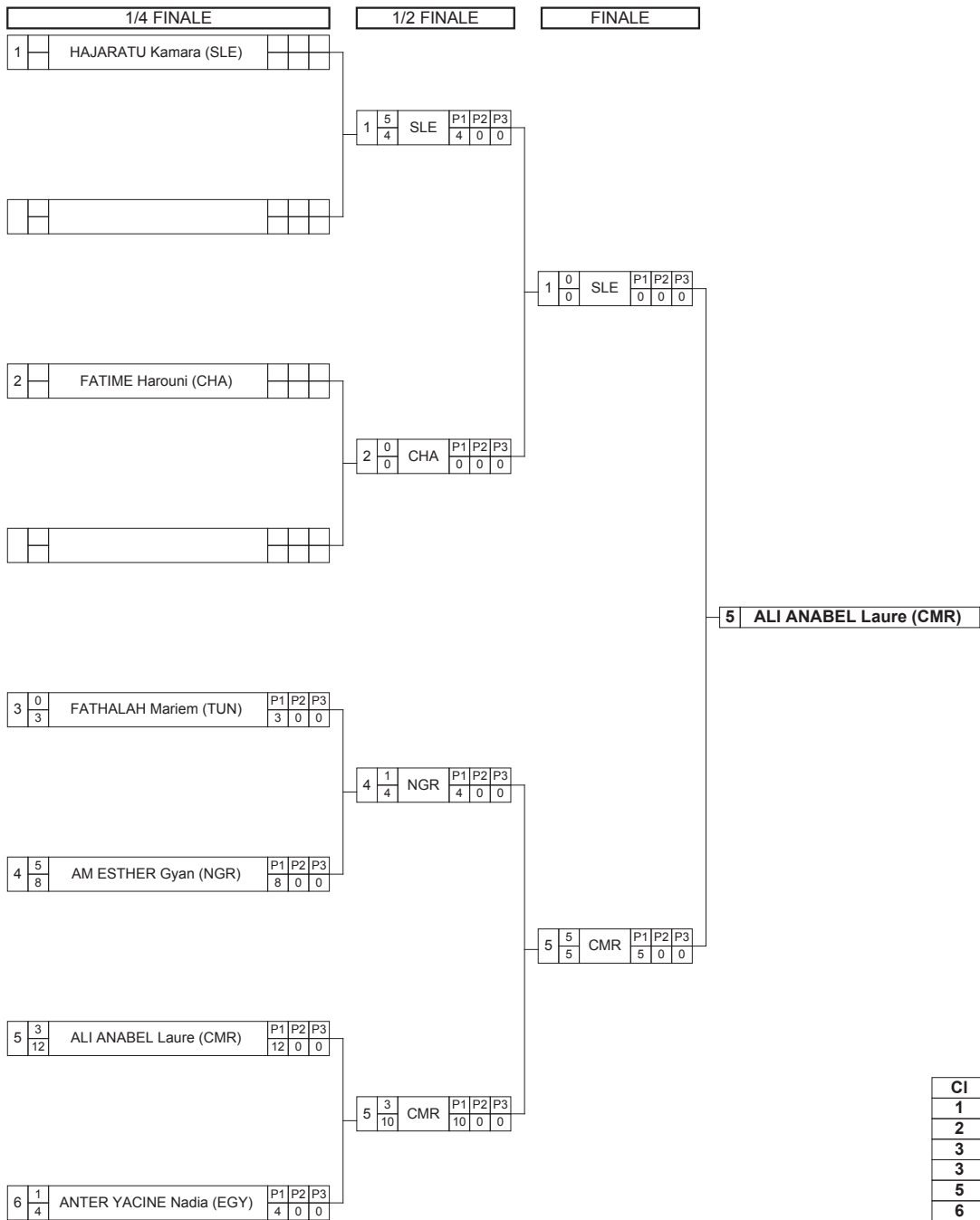

Classement

| Cl | Pays | Nom |
|----|------|--------------------|
| 1 | CMR | ALI ANABEL Laure |
| 2 | SLE | HAJARATU Kamara |
| 3 | EGY | ANTER YACINE Nadia |
| 3 | CHA | FATIME Harouni |
| 5 | NGR | AM ESTHER Gyan |
| 6 | TUN | FATHALAH Mariem |

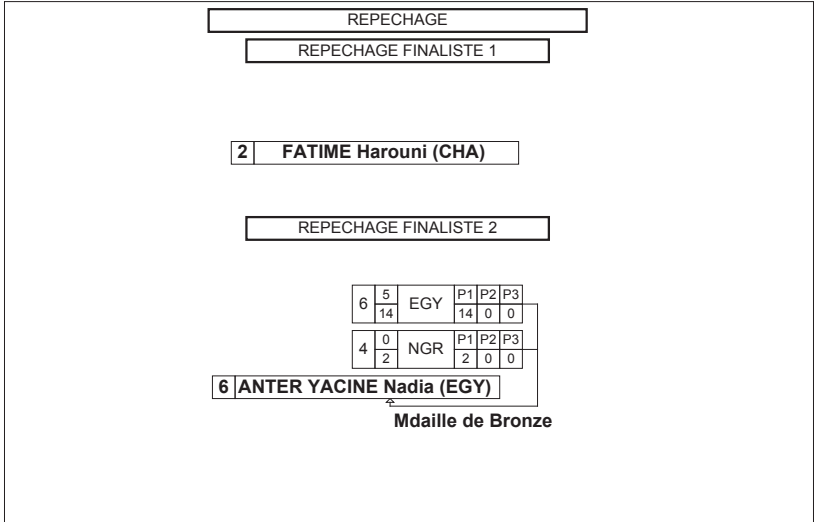



Classement

African Championship Senior

STYLE : FW 75 kg



1 - Or / Gold



ALI ANABEL Laure

2 - Argent / Silver



HAJARATU Kamara

3 - Bronze



ANTER YACINE Nadia



FATIME Harouni

| Classement | Nom - Name | Pays - Country |
|------------|--------------------|----------------|
| 1 | ALI ANABEL Laure | CMR |
| 2 | HAJARATU Kamara | SLE |
| 3 | ANTER YACINE Nadia | EGY |
| 3 | FATIME Harouni | CHA |
| 5 | AM ESTHER Gyan | NGR |
| 6 | FATHALAH Mariem | TUN |

AFRICAN CHAMPIONSHIP SENIOR



TUNIS (TUN)

2014-03-28 - 2014-03-30 2014

Résultats - Results

Lutte Greco-Romaine - Greco-Roman



**Liste des arbitres / Referee list****African Championship Senior**

| N° | Licence | Pays Country | Nom - Last Name | Prénom - First Name |
|-----------|----------------|-------------------------|------------------------|----------------------------|
| | | ALG | DOGHDOGH | Hamza |
| | | ALG | FETIAR | Riadh |
| | | ALG | MERDADI | Faouzi |
| | | ALG | NAANAA | Yacine |
| | | ALG | SIGUERDJDJENE | Omar |
| | | ALG | TRAI | Belcacem |
| | | EGY | AHMAD ZAKI | Salman |
| | | EGY | HALAWA | Cherif Ali |
| | | EGY | MOHAMED | Etman |
| | | JOR | MAHMOUD | Alaziz |
| | | JOR | MUNIERAL | Sallaq |
| | | JOR | NAIEF | Aloush |
| | | MAR | ZAIMI | Abdallah |
| | | NGR | USMAN | Yusuf |
| | | SAM | CHARLE | Vallet |
| | | SEN | NGOM | Malik |
| | | TUN | BOUSLAHI | Mohamed |
| | | TUN | KHARAZI | Jamel |
| | | TUN | MANAI | Hedi |
| | | TUN | ZERMDINI | Tayeb |

Nombre d'arbitres - Number of Referee

20









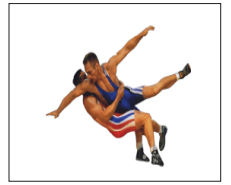

Liste des nations / Countries List

African Championship Senior

STYLE GR



Pays - Country

| | | |
|---|--------------|-----|
|  | ALGERIA | ALG |
|  | CHAD | CHA |
|  | CONGO | CGO |
|  | EGYPT | EGY |
|  | MOROCCO | MAR |
|  | SIERRA LEONE | SLE |
|  | SOUTH AFRICA | RSA |
|  | TUNISIA | TUN |

Nombre de nations - Number of Countries

**Nombre d'engagés par nation / Number of Entries By Country****African Championship Senior**

STYLE GR



| <i>Pays - Country</i> | <i>130 KG</i> | <i>59 KG</i> | <i>66 KG</i> | <i>71 KG</i> | <i>75 KG</i> | <i>80 KG</i> | <i>85 KG</i> | <i>98 KG</i> | <i>TOTAL</i> |
|-----------------------|---------------|--------------|--------------|--------------|--------------|--------------|--------------|--------------|--------------|
| ALG | | 1 | 1 | 1 | 1 | 1 | | | 5 |
| CGO | | 1 | 1 | 1 | | | | | 3 |
| CHA | 1 | | 1 | 1 | | | | 1 | 4 |
| EGY | | 1 | 1 | 1 | | 1 | 1 | 1 | 6 |
| MAR | 1 | 1 | 1 | 1 | 1 | 1 | 1 | 1 | 8 |
| RSA | | | | | 1 | | | | 1 |
| SLE | | | | | 1 | | | | 1 |
| TUN | 1 | 1 | 1 | 1 | 1 | 1 | 1 | 1 | 8 |
| TOTAL | 3 | 5 | 6 | 6 | 5 | 4 | 3 | 4 | 36 |

Nombre de nations - Number of Countries **8**



Liste des Engagés par pays / Entry-List By Country

African Championship Senior

STYLE GR

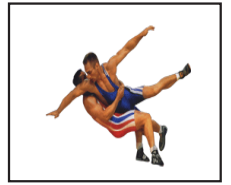

ALGERIA (ALG)

Lutteur(s) / Wrestler(s) :

| | |
|-------|-----------------------|
| 59 kg | BEN BRIH, Bilel |
| 66 kg | BEN AISSA, Terek Aziz |
| 71 kg | BOUDJAMLIN, Akram |
| 75 kg | OUAKALI, Abdelkrim |
| 80 kg | BLOUDDJEMLINE, Adem |

CHAD (CHA)

Lutteur(s) / Wrestler(s) :

| | |
|--------|------------------------|
| 130 kg | DIEUDONNE, Basile |
| 66 kg | HAMDI HANASSOU, Idriss |
| 71 kg | MADJIADOUM, Kasimir |
| 98 kg | MALICK, Djackna |

CONGO (CGO)

Lutteur(s) / Wrestler(s) :

| | |
|-------|-----------------|
| 59 kg | BOUBA, Herman |
| 66 kg | MBOUMA, Noel |
| 71 kg | BOUKAKA, Borcel |

EGYPT (EGY)

Lutteur(s) / Wrestler(s) :

| | |
|-------|-------------------|
| 59 kg | FAHMY, Haithem |
| 66 kg | ABDELMOMEN, Sayed |
| 71 kg | IBRAHIM, Ayad |
| 80 kg | MOUSTAFA, Mohamed |
| 85 kg | ZAGHLOL, Mohamed |
| 98 kg | OTHMAN, Ahmed |

MOROCCO (MAR)

Lutteur(s) / Wrestler(s) :

| | |
|--------|---------------------------|
| 130 kg | EL MKBER, Anas |
| 59 kg | FAJARI, Fouad |
| 66 kg | BAN ABDULOUHAB, Nouredine |
| 71 kg | BOUELEM, Aziz |



Liste des Engagés par pays / Entry-List By Country

African Championship Senior

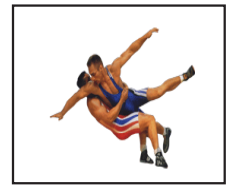

STYLE GR

| | |
|-------|----------------------|
| 75 kg | SARDI, Yassine |
| 80 kg | MOUANISS, Reda |
| 85 kg | BOUMADIENE, Hamza |
| 98 kg | BOUROUIHIAYA, Anouar |

SIERRA LEONE (SLE)

Lutteur(s) / Wrestler(s) :

| | |
|-------|----------------|
| 75 kg | SALAM, Abdulaj |
|-------|----------------|

SOUTH AFRICA (RSA)

Lutteur(s) / Wrestler(s) :

| | |
|-------|------------------|
| 75 kg | GERINGER, Zander |
|-------|------------------|

TUNISIA (TUN)

Lutteur(s) / Wrestler(s) :

| | |
|--------|----------------------|
| 130 kg | CHEBI, Radhouen |
| 59 kg | BOUTHOURI, Seber |
| 66 kg | BEN NASSER, Yassine |
| 71 kg | TRABELSI, Hakym |
| 75 kg | ZYETOKRAM, Zied |
| 80 kg | MISSAOUI, M. Skander |
| 85 kg | ACHOURI, Haykel |
| 98 kg | AYARI, Hassine |



Feuille de compétition / Competition Sheet

African Championship Senior

STYLE : GR 130 kg



TOUR : 1

| | | | | | | | |
|---|--------|------------------------|---------|---------|---------|---|----------------------|
| 1 | 4 8 | CHEBI Radhouen (TUN) | P1 8 | P2 0 | P3 0 | 1 | CHEBI Radhouen (TUN) |
| 2 | 0 0 | DIEUDONNE Basile (CHA) | P1 0 | P2 0 | P3 0 | | |

TOUR : 2

| | | | | | | | |
|---|--------|----------------------|---------|---------|---------|---|----------------------|
| 3 | 0 0 | EL MKBER Anas (MAR) | P1 0 | P2 0 | P3 0 | 1 | CHEBI Radhouen (TUN) |
| 1 | 4 8 | CHEBI Radhouen (TUN) | P1 8 | P2 0 | P3 0 | | |

TOUR : 3

| | | | | | | | |
|---|--------|------------------------|---------|---------|---------|---|---------------------|
| 2 | 0 1 | DIEUDONNE Basile (CHA) | P1 1 | P2 0 | P3 0 | 3 | EL MKBER Anas (MAR) |
| 3 | 4 2 | EL MKBER Anas (MAR) | P1 2 | P2 0 | P3 0 | | |

Classement

| Cl | Pays | Nom | Points |
|----|------|------------------|--------|
| 1 | TUN | CHEBI Radhouen | 8 |
| 2 | MAR | EL MKBER Anas | 4 |
| 3 | CHA | DIEUDONNE Basile | 0 |



Classement

African Championship Senior

STYLE : GR 130 kg



1 - Or / Gold



CHEBI Radhouen

2 - Argent / Silver



EL MKBER Anas

3 - Bronze



DIEUDONNE Basile

| <i>Classement</i> | <i>Nom - Name</i> | <i>Pays - Country</i> | <i>Points</i> |
|-------------------|-------------------|-----------------------|---------------|
| 1 | CHEBI Radhouen | TUN | 8 |
| 2 | EL MKBER Anas | MAR | 4 |
| 3 | DIEUDONNE Basile | CHA | 0 |



Feuille de compétition / Competition Sheet

African Championship Senior

STYLE : GR 59 kg



TOUR : 1

| | | | | | | | |
|---|--------|-----------------------|---------|---------|---------|---|-----------------------|
| 1 | 0 0 | BOUBA Herman (CGO) | P1 0 | P2 0 | P3 0 | 2 | BOUTHOURI Seber (TUN) |
| 2 | 4 8 | BOUTHOURI Seber (TUN) | P1 8 | P2 0 | P3 0 | | |
| 3 | 3 4 | FAHMY Haithem (EGY) | P1 4 | P2 0 | P3 0 | 3 | FAHMY Haithem (EGY) |
| 4 | 0 0 | BEN BRIH Bilel (ALG) | P1 0 | P2 0 | P3 0 | | |

TOUR : 2

| | | | | | | | |
|---|--------|-----------------------|---------|---------|---------|---|---------------------|
| 5 | 4 8 | FAJARI Fouad (MAR) | P1 8 | P2 0 | P3 0 | 5 | FAJARI Fouad (MAR) |
| 1 | 0 0 | BOUBA Herman (CGO) | P1 0 | P2 0 | P3 0 | | |
| 2 | 0 0 | BOUTHOURI Seber (TUN) | P1 0 | P2 0 | P3 0 | 3 | FAHMY Haithem (EGY) |
| 3 | 4 9 | FAHMY Haithem (EGY) | P1 9 | P2 0 | P3 0 | | |

TOUR : 3

| | | | | | | | |
|---|---------|-----------------------|----------|---------|---------|---|----------------------|
| 4 | 4 10 | BEN BRIH Bilel (ALG) | P1 10 | P2 0 | P3 0 | 4 | BEN BRIH Bilel (ALG) |
| 1 | 1 2 | BOUBA Herman (CGO) | P1 2 | P2 0 | P3 0 | | |
| 5 | 4 7 | FAJARI Fouad (MAR) | P1 7 | P2 0 | P3 0 | 5 | FAJARI Fouad (MAR) |
| 2 | 0 2 | BOUTHOURI Seber (TUN) | P1 2 | P2 0 | P3 0 | | |

TOUR : 4

| | | | | | | | |
|---|--------|----------------------|---------|---------|---------|---|---------------------|
| 3 | 4 2 | FAHMY Haithem (EGY) | P1 2 | P2 0 | P3 0 | 3 | FAHMY Haithem (EGY) |
| 1 | 0 0 | BOUBA Herman (CGO) | P1 0 | P2 0 | P3 0 | | |
| 4 | 1 2 | BEN BRIH Bilel (ALG) | P1 2 | P2 0 | P3 0 | 5 | FAJARI Fouad (MAR) |
| 5 | 3 6 | FAJARI Fouad (MAR) | P1 6 | P2 0 | P3 0 | | |

TOUR : 5

| | | | | | | | |
|---|--------|-----------------------|---------|---------|---------|---|----------------------|
| 2 | 0 0 | BOUTHOURI Seber (TUN) | P1 0 | P2 0 | P3 0 | 4 | BEN BRIH Bilel (ALG) |
| 4 | 4 0 | BEN BRIH Bilel (ALG) | P1 0 | P2 0 | P3 0 | | |
| 3 | 4 8 | FAHMY Haithem (EGY) | P1 8 | P2 0 | P3 0 | 3 | FAHMY Haithem (EGY) |
| 5 | 0 0 | FAJARI Fouad (MAR) | P1 0 | P2 0 | P3 0 | | |

Classement

| Cl | Pays | Nom | Points |
|----|------|-----------------|--------|
| 1 | EGY | FAHMY Haithem | 15 |
| 2 | MAR | FAJARI Fouad | 11 |
| 3 | ALG | BEN BRIH Bilel | 9 |
| 4 | TUN | BOUTHOURI Seber | 4 |
| 5 | CGO | BOUBA Herman | 1 |



Classement

African Championship Senior

STYLE : GR 59 kg



1 - Or / Gold



FAHMY Haithem

2 - Argent / Silver



FAJARI Fouad

3 - Bronze



BEN BRIH Bilel

| <i>Classement</i> | <i>Nom - Name</i> | <i>Pays - Country</i> | <i>Points</i> |
|-------------------|-------------------|-----------------------|---------------|
| 1 | FAHMY Haithem | EGY | 15 |
| 2 | FAJARI Fouad | MAR | 11 |
| 3 | BEN BRIH Bilel | ALG | 9 |
| 4 | BOUTHOURI Seber | TUN | 4 |
| 5 | BOUBA Herman | CGO | 1 |



Feuille de compétition / Competition Sheet

African Championship Senior



STYLE : GR 66 kg

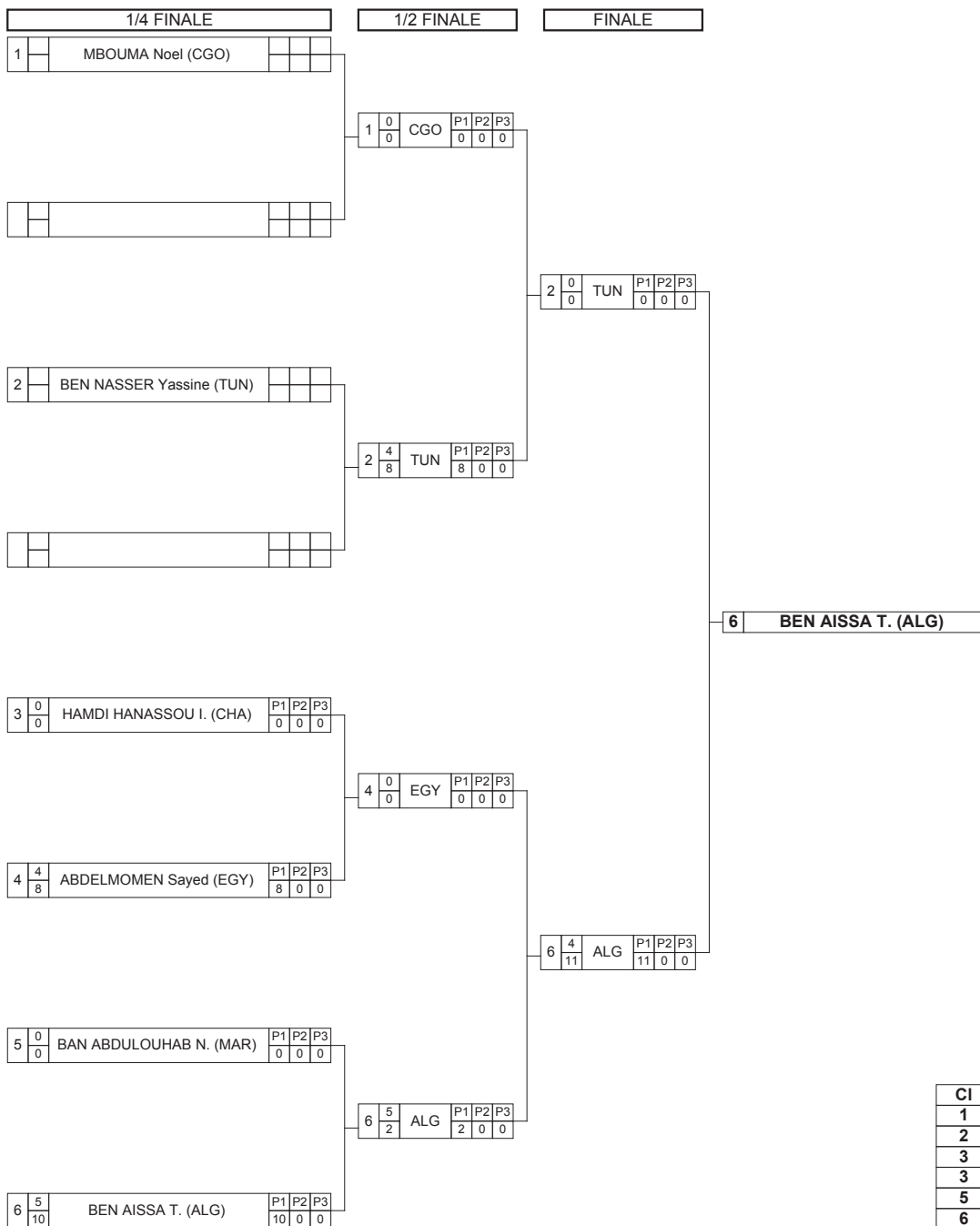

Classement

| Cl | Pays | Nom |
|----|------|---------------------------|
| 1 | ALG | BEN AISSA Terek Aziz |
| 2 | TUN | BEN NASSER Yassine |
| 3 | EGY | ABDELMOMEN Sayed |
| 3 | CGO | MBOUMA Noel |
| 5 | MAR | BAN ABDULOUHAB Noureddine |
| 6 | CHA | HAMDI HANASSOU Idriss |

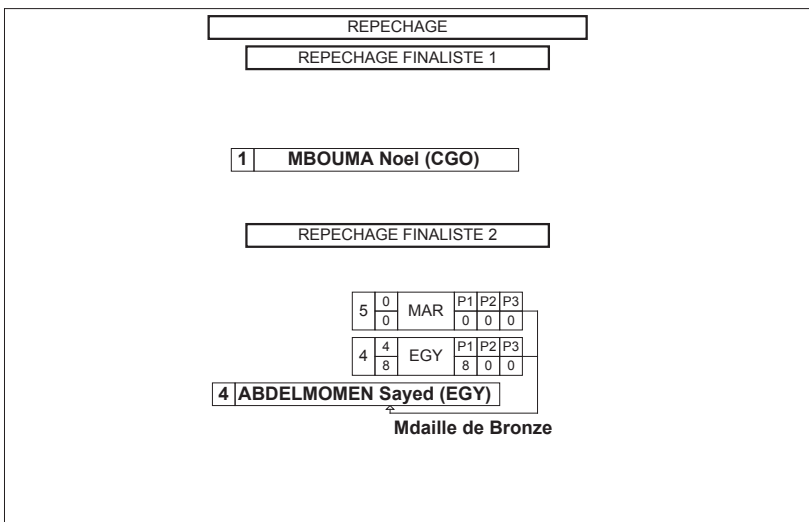



Classement

African Championship Senior

STYLE : GR 66 kg



1 - Or / Gold



BEN AISSA Terek Aziz

2 - Argent / Silver



BEN NASSER Yassine

3 - Bronze



ABDELMOMEN Sayed



MBOUMA Noel

| Classement | Nom - Name | Pays - Country |
|------------|--------------------|----------------|
| 1 | BEN AISSA T. | ALG |
| 2 | BEN NASSER Yassine | TUN |
| 3 | ABDELMOMEN Sayed | EGY |
| 3 | MBOUMA Noel | CGO |
| 5 | BAN ABDULOUHAB N. | MAR |
| 6 | HAMDI HANASSOU I. | CHA |



Feuille de compétition / Competition Sheet

African Championship Senior

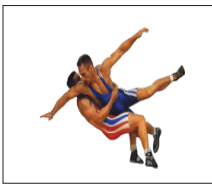

STYLE : GR 71 kg

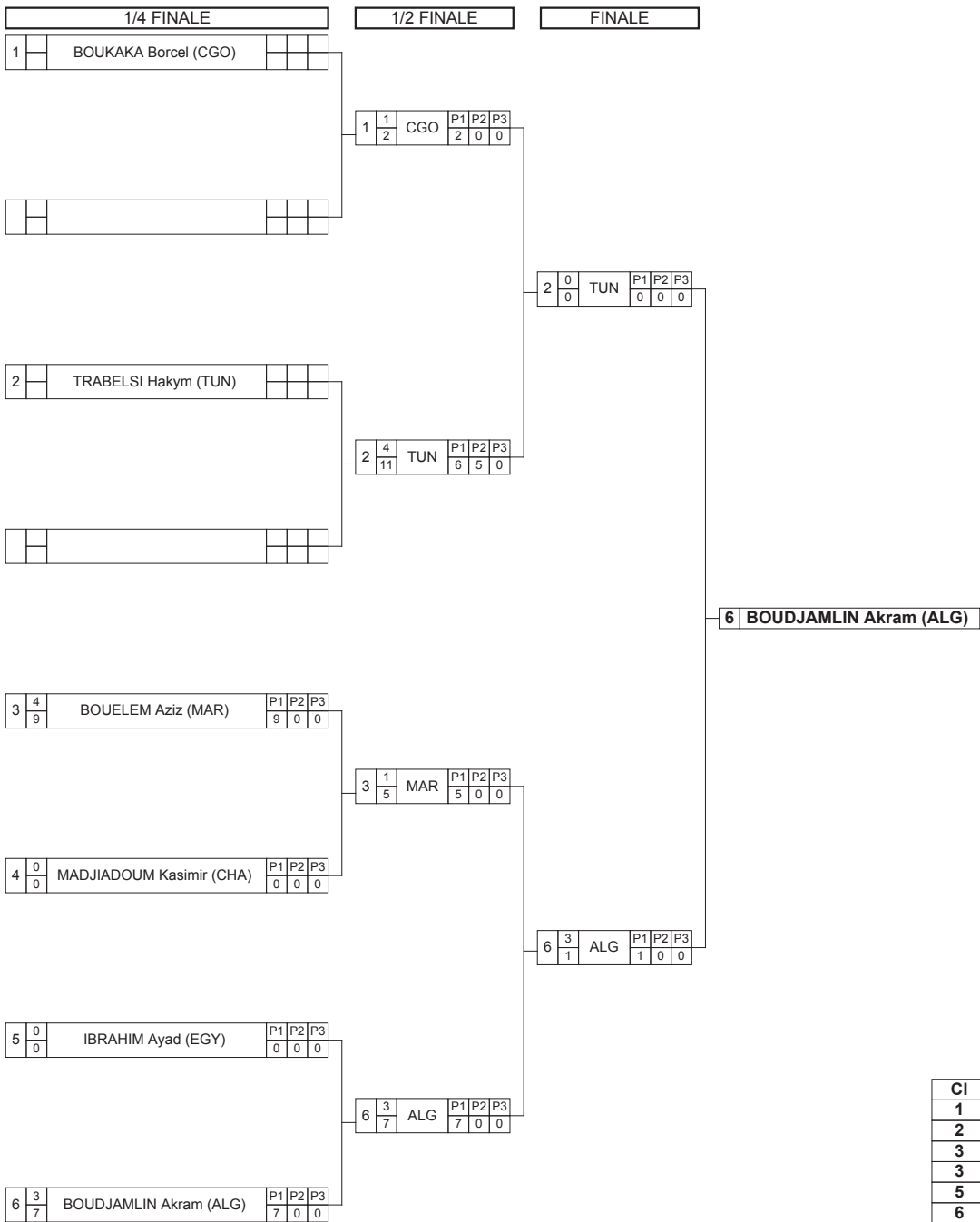

Classement

| Cl | Pays | Nom |
|----|------|-------------------|
| 1 | ALG | BOUDJAMLIN Akram |
| 2 | TUN | TRABELSI Hakym |
| 3 | EGY | IBRAHIM Ayad |
| 3 | CGO | BOUKAKA Borcel |
| 5 | MAR | BOUELEM Aziz |
| 6 | CHA | MADJIADOU Kasimir |

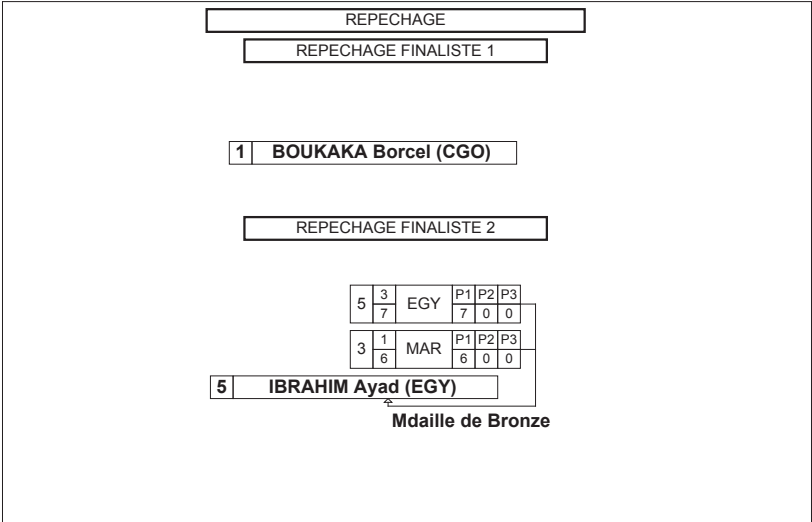



Classement

African Championship Senior

STYLE : GR 71 kg



1 - Or / Gold



BOUDJAMLIN Akram

2 - Argent / Silver



TRABELSI Hakym

3 - Bronze



IBRAHIM Ayad



BOUKAKA Borcel

| Classement | Nom - Name | Pays - Country |
|------------|--------------------|----------------|
| 1 | BOUDJAMLIN Akram | ALG |
| 2 | TRABELSI Hakym | TUN |
| 3 | IBRAHIM Ayad | EGY |
| 3 | BOUKAKA Borcel | CGO |
| 5 | BOUELEM Aziz | MAR |
| 6 | MADJIADOUM Kasimir | CHA |



Feuille de compétition / Competition Sheet

African Championship Senior

STYLE : GR 75 kg



TOUR : 1

| | | | | | | | |
|---|--------|-------------------------|---------|---------|---------|---|-------------------------|
| 1 | 0 0 | SARDI Yassine (MAR) | P1 0 | P2 0 | P3 0 | 2 | ZYETOKRAM Zied (TUN) |
| 2 | 4 4 | ZYETOKRAM Zied (TUN) | P1 4 | P2 0 | P3 0 | | |
| 3 | 4 4 | OUAKALI Abdelkrim (ALG) | P1 4 | P2 0 | P3 0 | 3 | OUAKALI Abdelkrim (ALG) |
| 4 | 0 0 | GERINGER Zander (RSA) | P1 0 | P2 0 | P3 0 | | |

TOUR : 2

| | | | | | | | |
|---|---------|-------------------------|----------|---------|---------|---|----------------------|
| 5 | 4 0 | SALAM Abdulaj (SLE) | P1 0 | P2 0 | P3 0 | 5 | SALAM Abdulaj (SLE) |
| 1 | 0 0 | SARDI Yassine (MAR) | P1 0 | P2 0 | P3 0 | | |
| 2 | 4 11 | ZYETOKRAM Zied (TUN) | P1 11 | P2 0 | P3 0 | 2 | ZYETOKRAM Zied (TUN) |
| 3 | 0 2 | OUAKALI Abdelkrim (ALG) | P1 2 | P2 0 | P3 0 | | |

TOUR : 3

| | | | | | | | |
|---|--------|-----------------------|---------|---------|---------|---|-----------------------|
| 4 | 4 0 | GERINGER Zander (RSA) | P1 0 | P2 0 | P3 0 | 4 | GERINGER Zander (RSA) |
| 1 | 0 0 | SARDI Yassine (MAR) | P1 0 | P2 0 | P3 0 | | |
| 5 | 0 0 | SALAM Abdulaj (SLE) | P1 0 | P2 0 | P3 0 | 2 | ZYETOKRAM Zied (TUN) |
| 2 | 4 8 | ZYETOKRAM Zied (TUN) | P1 8 | P2 0 | P3 0 | | |

TOUR : 4

| | | | | | | | |
|---|--------|-------------------------|---------|---------|---------|---|-------------------------|
| 3 | 4 0 | OUAKALI Abdelkrim (ALG) | P1 0 | P2 0 | P3 0 | 3 | OUAKALI Abdelkrim (ALG) |
| 1 | 0 0 | SARDI Yassine (MAR) | P1 0 | P2 0 | P3 0 | | |
| 4 | 0 0 | GERINGER Zander (RSA) | P1 0 | P2 0 | P3 0 | 5 | SALAM Abdulaj (SLE) |
| 5 | 4 8 | SALAM Abdulaj (SLE) | P1 8 | P2 0 | P3 0 | | |

TOUR : 5

| | | | | | | | |
|---|--------|-------------------------|---------|---------|---------|---|-------------------------|
| 2 | 4 9 | ZYETOKRAM Zied (TUN) | P1 9 | P2 0 | P3 0 | 2 | ZYETOKRAM Zied (TUN) |
| 4 | 0 0 | GERINGER Zander (RSA) | P1 0 | P2 0 | P3 0 | | |
| 3 | 3 4 | OUAKALI Abdelkrim (ALG) | P1 4 | P2 0 | P3 0 | 3 | OUAKALI Abdelkrim (ALG) |
| 5 | 1 2 | SALAM Abdulaj (SLE) | P1 2 | P2 0 | P3 0 | | |

Classement

| Cl | Pays | Nom | Points |
|----|------|-------------------|--------|
| 1 | TUN | ZYETOKRAM Zied | 16 |
| 2 | ALG | OUAKALI Abdelkrim | 11 |
| 3 | SLE | SALAM Abdulaj | 9 |
| 4 | RSA | GERINGER Zander | 4 |
| 5 | MAR | SARDI Yassine | 0 |



Classement

African Championship Senior

STYLE : GR 75 kg



1 - Or / Gold



ZYETOKRAM Zied

2 - Argent / Silver



OUAKALI Abdelkrim

3 - Bronze



SALAM Abdulaj

| <i>Classement</i> | <i>Nom - Name</i> | <i>Pays - Country</i> | <i>Points</i> |
|-------------------|-------------------|-----------------------|---------------|
| 1 | ZYETOKRAM Zied | TUN | 16 |
| 2 | OUAKALI Abdelkrim | ALG | 11 |
| 3 | SALAM Abdulaj | SLE | 9 |
| 4 | GERINGER Zander | RSA | 4 |
| 5 | SARDI Yassine | MAR | 0 |



Feuille de compétition / Competition Sheet

African Championship Senior

STYLE : GR 80 kg



TOUR : 1

| | | | | | | | |
|---|---------------|--------------------------|----|----|----|---|------------------------|
| 1 | $\frac{3}{5}$ | MISSAOUI M. (TUN) | P1 | P2 | P3 | 1 | MISSAOUI M. (TUN) |
| | | | 5 | 0 | 0 | | |
| 2 | $\frac{1}{4}$ | BLOUDDJEMLINE Adem (ALG) | P1 | P2 | P3 | | |
| | | | 4 | 0 | 0 | | |
| 3 | $\frac{4}{9}$ | MOUSTAFA Mohamed (EGY) | P1 | P2 | P3 | 3 | MOUSTAFA Mohamed (EGY) |
| | | | 9 | 0 | 0 | | |
| 4 | $\frac{0}{0}$ | MOUANISS Reda (MAR) | P1 | P2 | P3 | | |
| | | | 0 | 0 | 0 | | |

TOUR : 2

| | | | | | | | |
|---|---------------|--------------------------|----|----|----|---|--------------------------|
| 1 | $\frac{0}{0}$ | MISSAOUI M. (TUN) | P1 | P2 | P3 | 3 | MOUSTAFA Mohamed (EGY) |
| | | | 0 | 0 | 0 | | |
| 3 | $\frac{4}{8}$ | MOUSTAFA Mohamed (EGY) | P1 | P2 | P3 | | |
| | | | 8 | 0 | 0 | | |
| 2 | $\frac{4}{4}$ | BLOUDDJEMLINE Adem (ALG) | P1 | P2 | P3 | 2 | BLOUDDJEMLINE Adem (ALG) |
| | | | 4 | 0 | 0 | | |
| 4 | $\frac{0}{1}$ | MOUANISS Reda (MAR) | P1 | P2 | P3 | | |
| | | | 1 | 0 | 0 | | |

TOUR : 3

| | | | | | | | |
|---|----------------|--------------------------|----|----|----|---|------------------------|
| 1 | $\frac{4}{10}$ | MISSAOUI M. (TUN) | P1 | P2 | P3 | 1 | MISSAOUI M. (TUN) |
| | | | 10 | 0 | 0 | | |
| 4 | $\frac{1}{2}$ | MOUANISS Reda (MAR) | P1 | P2 | P3 | | |
| | | | 2 | 0 | 0 | | |
| 2 | $\frac{1}{1}$ | BLOUDDJEMLINE Adem (ALG) | P1 | P2 | P3 | 3 | MOUSTAFA Mohamed (EGY) |
| | | | 1 | 0 | 0 | | |
| 3 | $\frac{3}{7}$ | MOUSTAFA Mohamed (EGY) | P1 | P2 | P3 | | |
| | | | 7 | 0 | 0 | | |

Classement

| Cl | Pays | Nom | Points |
|----|------|---------------------|--------|
| 1 | EGY | MOUSTAFA Mohamed | 11 |
| 2 | TUN | MISSAOUI M. Skander | 7 |
| 3 | ALG | BLOUDDJEMLINE Adem | 6 |
| 4 | MAR | MOUANISS Reda | 1 |



Classement

African Championship Senior

STYLE : GR 80 kg



1 - Or / Gold



MOUSTAFA Mohamed

2 - Argent / Silver



MISSAOUI M. Skander

3 - Bronze



BLOUDDJEMLINE Adem

| <i>Classement</i> | <i>Nom - Name</i> | <i>Pays - Country</i> | <i>Points</i> |
|-------------------|---------------------|-----------------------|---------------|
| 1 | MOUSTAFA Mohamed | EGY | 11 |
| 2 | MISSAOUI M. Skander | TUN | 7 |
| 3 | BLOUDDJEMLINE Adem | ALG | 6 |
| 4 | MOUANISS Reda | MAR | 1 |



Feuille de compétition / Competition Sheet

African Championship Senior

STYLE : GR 85 kg



TOUR : 1

| | | | | | | | |
|---|---------------|------------------------|----|----|----|---|-----------------------|
| 1 | $\frac{3}{6}$ | ZAGHLOL Mohamed (EGY) | P1 | P2 | P3 | 1 | ZAGHLOL Mohamed (EGY) |
| | | | 6 | 0 | 0 | | |
| 2 | $\frac{1}{2}$ | BOUMADIENE Hamza (MAR) | P1 | P2 | P3 | | |
| | | | 2 | 0 | 0 | | |

TOUR : 2

| | | | | | | | |
|---|---------------|-----------------------|----|----|----|---|----------------------|
| 3 | $\frac{4}{8}$ | ACHOURI Haykel (TUN) | P1 | P2 | P3 | 3 | ACHOURI Haykel (TUN) |
| | | | 8 | 0 | 0 | | |
| 1 | $\frac{0}{0}$ | ZAGHLOL Mohamed (EGY) | P1 | P2 | P3 | | |
| | | | 0 | 0 | 0 | | |

TOUR : 3

| | | | | | | | |
|---|---------------|------------------------|----|----|----|---|----------------------|
| 2 | $\frac{0}{0}$ | BOUMADIENE Hamza (MAR) | P1 | P2 | P3 | 3 | ACHOURI Haykel (TUN) |
| | | | 0 | 0 | 0 | | |
| 3 | $\frac{4}{8}$ | ACHOURI Haykel (TUN) | P1 | P2 | P3 | | |
| | | | 8 | 0 | 0 | | |

Classement

| Cl | Pays | Nom | Points |
|----|------|------------------|--------|
| 1 | TUN | ACHOURI Haykel | 8 |
| 2 | EGY | ZAGHLOL Mohamed | 3 |
| 3 | MAR | BOUMADIENE Hamza | 1 |



Classement

African Championship Senior

STYLE : GR 85 kg



1 - Or / Gold



ACHOURI Haykel

2 - Argent / Silver



ZAGHLOL Mohamed

3 - Bronze



BOUMADIENE Hamza

| <i>Classement</i> | <i>Nom - Name</i> | <i>Pays - Country</i> | <i>Points</i> |
|-------------------|-------------------|-----------------------|---------------|
| 1 | ACHOURI Haykel | TUN | 8 |
| 2 | ZAGHLOL Mohamed | EGY | 3 |
| 3 | BOUMADIENE Hamza | MAR | 1 |



Feuille de compétition / Competition Sheet

African Championship Senior

STYLE : GR 98 kg



TOUR : 1

| | | | | | | | |
|---|----------------|-----------------------|----|----|----|---|---------------------|
| 1 | $\frac{4}{10}$ | AYARI Hassine (TUN) | P1 | P2 | P3 | 1 | AYARI Hassine (TUN) |
| | | | 10 | 0 | 0 | | |
| 2 | $\frac{0}{0}$ | BOUROUIHIAYA A. (MAR) | P1 | P2 | P3 | | |
| | | | 0 | 0 | 0 | | |
| 3 | $\frac{0}{0}$ | MALICK Djackna (CHA) | P1 | P2 | P3 | 4 | OTHMAN Ahmed (EGY) |
| | | | 0 | 0 | 0 | | |
| 4 | $\frac{4}{8}$ | OTHMAN Ahmed (EGY) | P1 | P2 | P3 | | |
| | | | 8 | 0 | 0 | | |

TOUR : 2

| | | | | | | | |
|---|----------------|-----------------------|----|----|----|---|---------------------|
| 1 | $\frac{4}{12}$ | AYARI Hassine (TUN) | P1 | P2 | P3 | 1 | AYARI Hassine (TUN) |
| | | | 12 | 0 | 0 | | |
| 3 | $\frac{0}{0}$ | MALICK Djackna (CHA) | P1 | P2 | P3 | | |
| | | | 0 | 0 | 0 | | |
| 2 | $\frac{0}{0}$ | BOUROUIHIAYA A. (MAR) | P1 | P2 | P3 | 4 | OTHMAN Ahmed (EGY) |
| | | | 0 | 0 | 0 | | |
| 4 | $\frac{4}{8}$ | OTHMAN Ahmed (EGY) | P1 | P2 | P3 | | |
| | | | 8 | 0 | 0 | | |

TOUR : 3

| | | | | | | | |
|---|---------------|-----------------------|----|----|----|---|----------------------|
| 1 | $\frac{1}{2}$ | AYARI Hassine (TUN) | P1 | P2 | P3 | 4 | OTHMAN Ahmed (EGY) |
| | | | 2 | 0 | 0 | | |
| 4 | $\frac{3}{4}$ | OTHMAN Ahmed (EGY) | P1 | P2 | P3 | | |
| | | | 4 | 0 | 0 | | |
| 2 | $\frac{0}{0}$ | BOUROUIHIAYA A. (MAR) | P1 | P2 | P3 | 3 | MALICK Djackna (CHA) |
| | | | 0 | 0 | 0 | | |
| 3 | $\frac{4}{8}$ | MALICK Djackna (CHA) | P1 | P2 | P3 | | |
| | | | 8 | 0 | 0 | | |

Classement

| Cl | Pays | Nom | Points |
|----|------|---------------------|--------|
| 1 | EGY | OTHMAN Ahmed | 11 |
| 2 | TUN | AYARI Hassine | 9 |
| 3 | CHA | MALICK Djackna | 4 |
| 4 | MAR | BOUROUIHIAYA Anouar | 0 |



Classement

African Championship Senior

STYLE : GR 98 kg



1 - Or / Gold



OTHMAN Ahmed

2 - Argent / Silver



AYARI Hassine

3 - Bronze



MALICK Djackna

| <i>Classement</i> | <i>Nom - Name</i> | <i>Pays - Country</i> | <i>Points</i> |
|-------------------|---------------------|-----------------------|---------------|
| 1 | OTHMAN Ahmed | EGY | 11 |
| 2 | AYARI Hassine | TUN | 9 |
| 3 | MALICK Djackna | CHA | 4 |
| 4 | BOUROUIHIAYA Anouar | MAR | 0 |



Classement par équipe / Teams ranking

African Championship Senior

STYLE GR



| Rang | Equipe | 130 KG | 59 KG | 66 KG | 71 KG | 75 KG | 80 KG | 85 KG | 98 KG | TOTAL |
|-------------|---------------|---------------|--------------|--------------|--------------|--------------|--------------|--------------|--------------|--------------|
| 1 | TUN | 10 | 7 | 9 | 9 | 10 | 9 | 10 | 9 | 73 |
| 2 | MAR | 9 | 9 | 6 | 6 | 6 | 7 | 8 | 7 | 58 |
| 3 | EGY | | 10 | 8 | 8 | | 10 | 9 | 10 | 55 |
| 4 | ALG | | 8 | 10 | 10 | 9 | 8 | | | 45 |
| 5 | CHA | 8 | | 5 | 5 | | | | 8 | 26 |
| 6 | CGO | | 6 | 8 | 8 | | | | | 22 |
| 7 | SLE | | | | | 8 | | | | 8 |
| 8 | RSA | | | | | 7 | | | | 7 |