

# 11TH WORLD UNIVERSITY WRESTLING CHAMPIONSHIP



PECS (HUN)

2014-07-07 - 2014-07-12 2014

Résultats - Results

Lutte Libre - Free-Style





Liste des arbitres / Referee list

11th World University Wrestling Championship



<i>N°</i>	<i>Licence</i>	<i>Pays Country</i>	<i>Nom - Last Name</i>	<i>Prénom - First Name</i>
-----------	----------------	-------------------------	------------------------	----------------------------





Liste des nations / Countries List

11th World University Wrestling Championship

STYLE FS



*Pays - Country*

	AUSTRIA	AUT
	BRAZIL	BRA
	BULGARIA	BUL
	CANADA	CAN
	FINLAND	FIN
	GERMANY	GER
	HUNGARY	HUN
	ISRAEL	ISR
	JAPAN	JPN
	KYRGYZSTAN	KGZ
	MOLDOVA	MDA
	MONGOLIA	MGL
	POLAND	POL
	ROMANIA	ROU
	RUSSIA	RUS
	SERBIA	SRB
	SLOVAKIA	SVK
	SPAIN	ESP
	TURKEY	TUR
	UKRAINE	UKR
	UNITED STATES	USA

Nombre de nations - Number of Countries 21

**Nombre d'engagés par nation / Number of Entries By Country****11th World University Wrestling Championship**

STYLE FS



<i>Pays - Country</i>	<b>125 KG</b>	<b>57 KG</b>	<b>61 KG</b>	<b>65 KG</b>	<b>70 KG</b>	<b>74 KG</b>	<b>86 KG</b>	<b>97 KG</b>	<b>TOTAL</b>
AUT					1				1
BRA						1	1		2
BUL	1	1	1	1	1	1	1		7
CAN	1		1	1	1	1	1		6
ESP				1					1
FIN					1		1		2
GER			1			1			2
HUN	1	1	1	1	1	1	1	1	8
ISR		1					1		2
JPN		1	1	1	1	1	1	1	7
KGZ		1	1			1	1		4
MDA	1	1	1	1	1	1	1	1	8
MGL		1	1	1				1	4
POL					1	1	1	1	4
ROU				1		1	1		3
RUS	1	1	1	1	1	1	1	1	8
SRB				1					1
SVK						1	1		2
TUR	1	1	1	1	1	1	1	1	8
UKR	1	1	1	1	1	1	1	1	8
USA	1	1	1	1	1	1	1	1	8
<b>TOTAL</b>	<b>8</b>	<b>11</b>	<b>12</b>	<b>13</b>	<b>12</b>	<b>15</b>	<b>16</b>	<b>9</b>	<b>96</b>

Nombre de nations - Number of Countries **21**



Liste des Engagés par pays / Entry-List By Country

11th World University Wrestling Championship

STYLE FS



**AUSTRIA (AUT)**

Lutteur(s) / Wrestler(s) :

70 kg MILADINOV, Mladen

**BRAZIL (BRA)**

Lutteur(s) / Wrestler(s) :

74 kg GABRIEL RENNO MARTINEZ, Sandro

86 kg MAIA DA NOBREGA, Jonatas Augusto

**BULGARIA (BUL)**

Lutteur(s) / Wrestler(s) :

125 kg TODOROV, Mariyan

57 kg FERAYM, Mehmed

61 kg IVANOV, Stefan

65 kg BOYCHEV, Boycho

70 kg MIHAYLOV, Mishel

74 kg MOLLA, Hasan

86 kg YURUKOV, Iren

**CANADA (CAN)**

Lutteur(s) / Wrestler(s) :

125 kg KOONER, Gurjot

61 kg SCHILLER, Scott

65 kg IWASA-MADGE, Kevin

70 kg HUTTON, Brian

74 kg DAYE-FINLEY, Shawn

86 kg OTTO, Riley

**FINLAND (FIN)**

Lutteur(s) / Wrestler(s) :

70 kg KUNNAS, Jere

86 kg HEINO, Ville

**GERMANY (GER)**

Lutteur(s) / Wrestler(s) :



## Liste des Engagés par pays / Entry-List By Country

### 11th World University Wrestling Championship

STYLE FS



61 kg DORN, Niklas  
74 kg HAST, Alexander

#### HUNGARY (HUN)

**Lutteur(s) / Wrestler(s) :**

125 kg CSERCSICS, Richard  
57 kg NYIRI, Milan  
61 kg NEMETH, Bela  
65 kg BABSZKY, Gergely  
70 kg GULYAS, Zsombor  
74 kg LAGZI KOVACS, Bendeguz  
86 kg TOZSER, Sandor  
97 kg SZABO, Mihaly

#### ISRAEL (ISR)

**Lutteur(s) / Wrestler(s) :**

57 kg ZOBKOV, Demitri  
86 kg BERNSTEIN, Ophir

#### JAPAN (JPN)

**Lutteur(s) / Wrestler(s) :**

57 kg MORISHITA, Fumitaka  
61 kg KAMOI, Masakazu  
65 kg SHINKAWA, Takeya  
70 kg SUNAGAWA, Kosuke  
74 kg KITAMURA, Kohei  
86 kg AKAGUMA, Naoya  
97 kg YAMAMOTO, Koki

#### KYRGYZSTAN (KGZ)

**Lutteur(s) / Wrestler(s) :**

57 kg ISAKOV, Imanbek  
61 kg SYPAR, Satymkulov  
74 kg ILGIZ, Dzhakypbekov  
86 kg AIBEK, Usupov



## Liste des Engagés par pays / Entry-List By Country

### 11th World University Wrestling Championship

STYLE FS



#### MOLDOVA (MDA)

**Lutteur(s) / Wrestler(s) :**

125 kg	ROMANOV, Alexandr
57 kg	CHIRTOACA, Alexandru
61 kg	SACULTAN, Vadim
65 kg	SAVA, Mihail
70 kg	NEDEALCO, Evgheni
74 kg	VASILACHI, Ion
86 kg	IANULOV, Piotr
97 kg	BALAUUR, Denis

#### MONGOLIA (MGL)

**Lutteur(s) / Wrestler(s) :**

57 kg	BYAMBADORJ, Khash-Erdene
61 kg	TUMENBILEG, Tuvshintulga
65 kg	BATCHULUUN, Batmagnai
97 kg	BATDORJ, Namkhai

#### POLAND (POL)

**Lutteur(s) / Wrestler(s) :**

70 kg	SZEJA, Arkadiusz
74 kg	SOKALSKI, Andrzej
86 kg	JEZIERZANSKI, Sebastian
97 kg	DUBLINOWSKI, Patryk

#### ROMANIA (ROU)

**Lutteur(s) / Wrestler(s) :**

65 kg	BUCUR, George
74 kg	ATOFANI, Marius Lucian
86 kg	FRANT, Andrei Victor

#### RUSSIA (RUS)

**Lutteur(s) / Wrestler(s) :**

125 kg	GUSEINOV, Magomedkamil
57 kg	PETROV, Vladislav
61 kg	SKRIABIN, Niurgun



## Liste des Engagés par pays / Entry-List By Country

### 11th World University Wrestling Championship



#### STYLE FS

65 kg	AKHMEDOV, Ruslan
70 kg	MAGOMEDOV, Shamil
74 kg	OSMANOV, Shamil-Imam
86 kg	KTSOEV, Oleg
97 kg	MAGOMEDOV, Badavi

#### SERBIA (SRB)

##### Lutteur(s) / Wrestler(s) :

65 kg	POPOVIC, Milan
-------	----------------

#### SLOVAKIA (SVK)

##### Lutteur(s) / Wrestler(s) :

74 kg	OLLE, Robert
86 kg	BODNÁ•R, Michael

#### SPAIN (ESP)

##### Lutteur(s) / Wrestler(s) :

65 kg	PERMUY SOTO, Eliseo
-------	---------------------

#### TURKEY (TUR)

##### Lutteur(s) / Wrestler(s) :

125 kg	BOZKURT, Sakir
57 kg	DAYLAK, Ziya
61 kg	AVCI, Ismail
65 kg	KILICSALLAYAN, Selahattin
70 kg	OKTAY, Mehmet
74 kg	GURBUZ, Musa
86 kg	KORKMAZ, Namik
97 kg	YASARLI, Fatih

#### UKRAINE (UKR)

##### Lutteur(s) / Wrestler(s) :

125 kg	VLASOV, Andriy
57 kg	BILEICHUK, Petro
61 kg	SHUKSHIN, Vadym
65 kg	DUKHNO, Vadym





Liste des Engagés par pays / Entry-List By Country

11th World University Wrestling Championship

STYLE FS



70 kg	ODYNAK, Serhii
74 kg	NAGORNYI, Andrii
86 kg	CHUIEV, Anton
97 kg	KUTEY, Hleb

**UNITED STATES (USA)**

**Lutteur(s) / Wrestler(s) :**

125 kg	FORTUNE, Tyrell
57 kg	MCDONOUGH, Matt
61 kg	FUTRELL, Bernard
65 kg	ASHNAULT, Anthony
70 kg	GREEN, James
74 kg	CALDWELL, Tyler
86 kg	PERRY, Chris
97 kg	KILGORE, Dustin



# Feuille de compétition / Competition Sheet

## 11th World University Wrestling Championship



STYLE : FS 125 kg

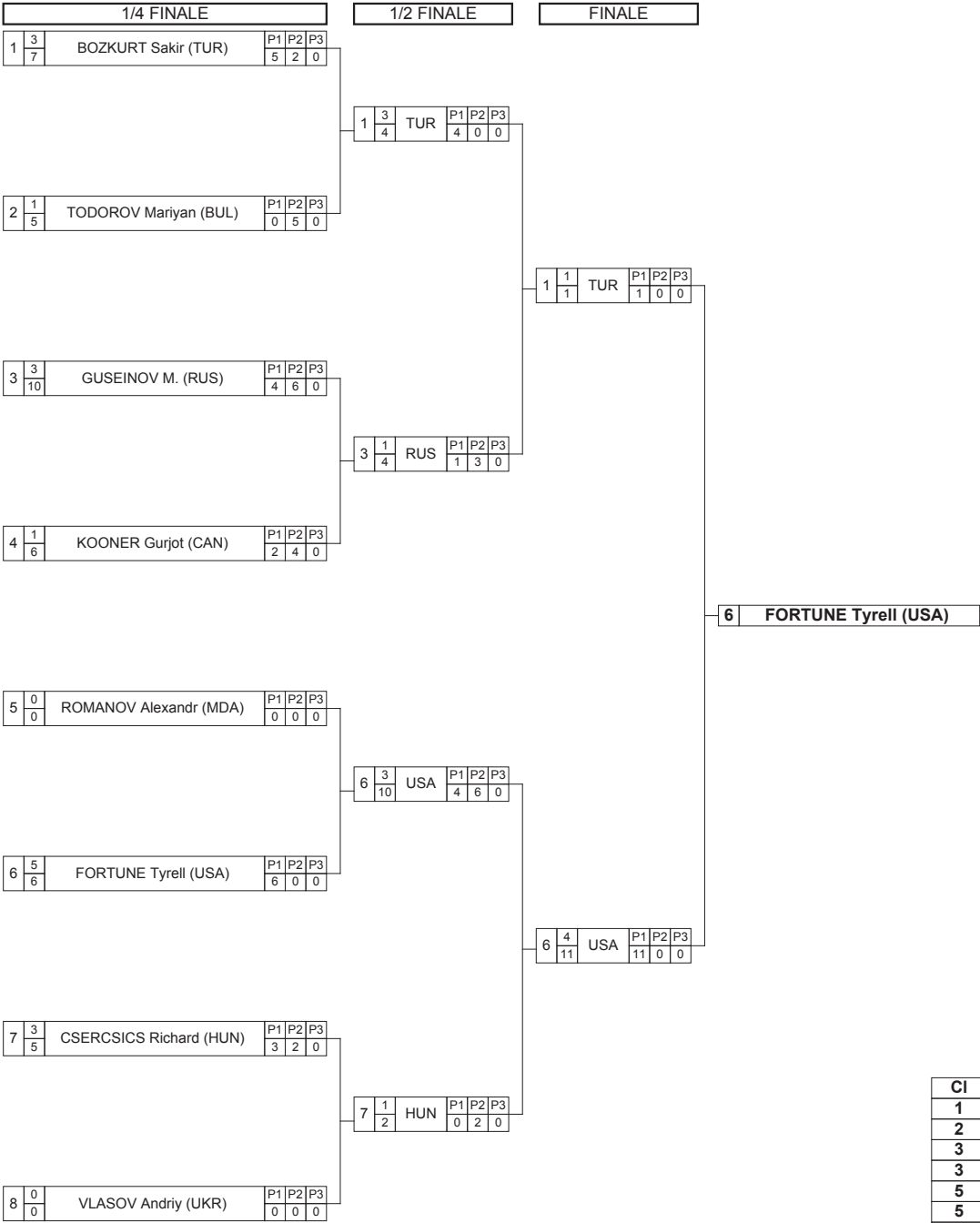

**Classement**

Cl	Pays	Nom
1	USA	FORTUNE Tyrell
2	TUR	BOZKURT Sakir
3	BUL	TODOROV Mariyan
3	HUN	CSERCICSICS Richard
5	RUS	GUSEINOV Magomedkamil
5	MDA	ROMANOV Alexandr
7	CAN	KOONER Gurjot
8	UKR	VLASOV Andriy

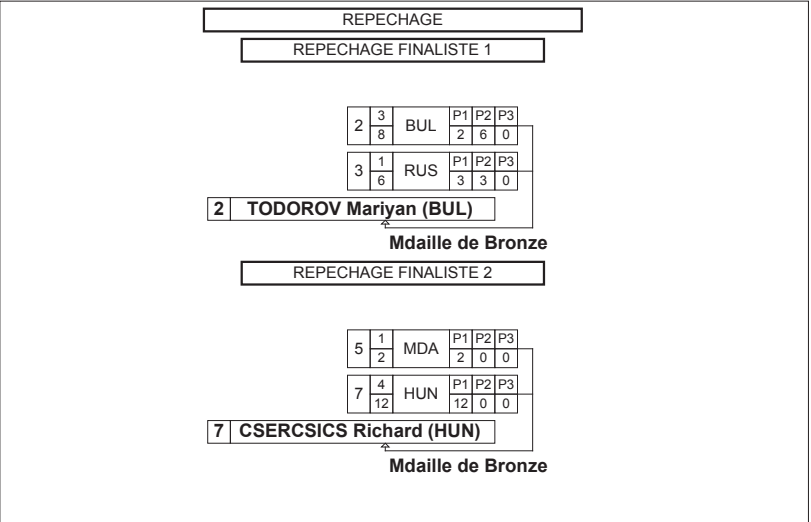



**Classement**

**11th World University Wrestling Championship**



STYLE : FS 125 kg

**1 - Or / Gold**



FORTUNE Tyrell

**2 - Argent / Silver**



BOZKURT Sakir

**3 - Bronze**



TODOROV Mariyan



CSERCSICS Richard

<i>Classement</i>	<i>Nom - Name</i>	<i>Pays - Country</i>
1	FORTUNE Tyrell	USA
2	BOZKURT Sakir	TUR
3	TODOROV Mariyan	BUL
3	CSERCSICS Richard	HUN
5	GUSEINOV M.	RUS
5	ROMANOV Alexandr	MDA
7	KOONER Gurjot	CAN
8	VLASOV Andriy	UKR



# Feuille de compétition / Competition Sheet

## 11th World University Wrestling Championship



STYLE : FS 57 kg

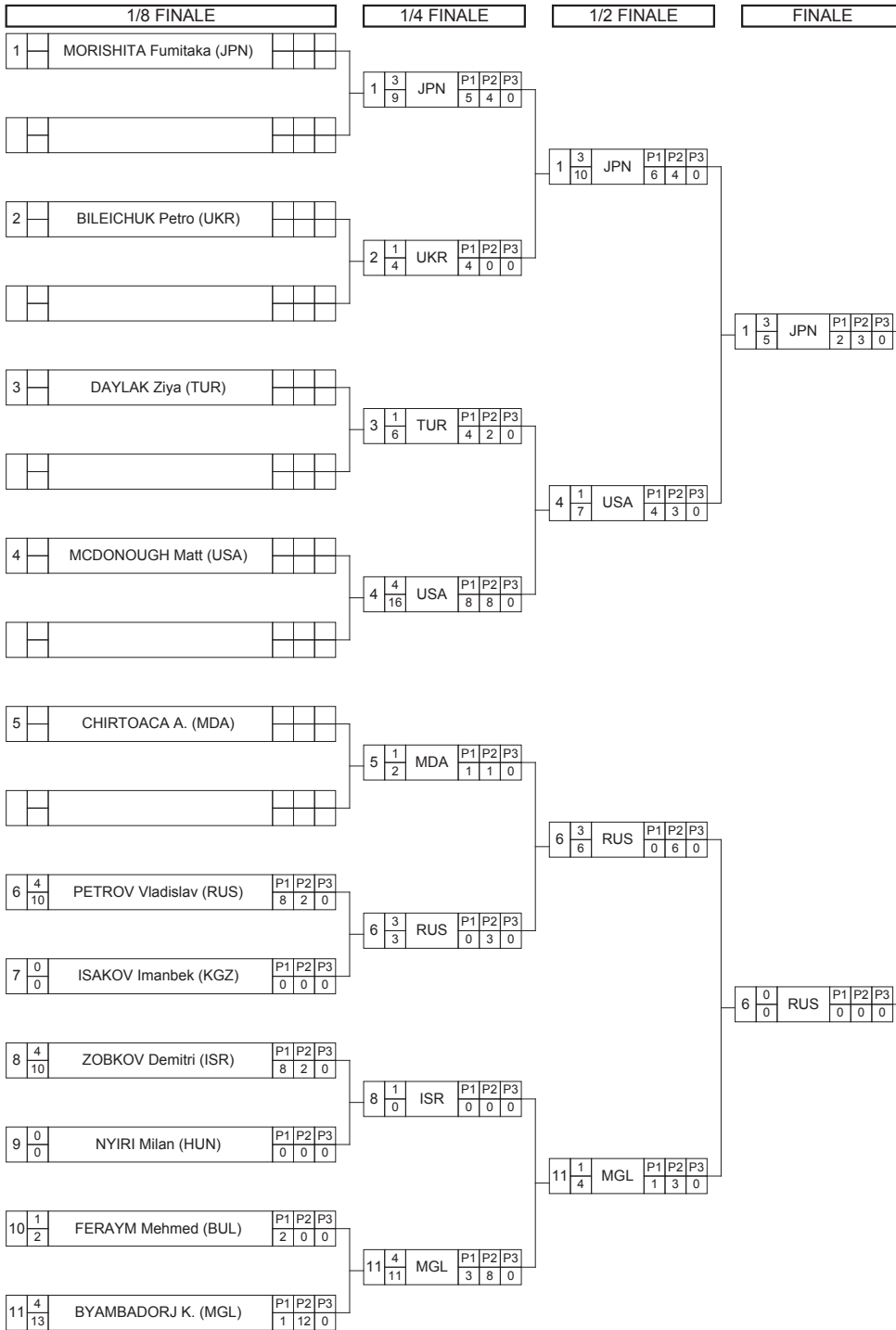

### Classement

Cl	Pays	Nom
1	JPN	MORISHITA Fumitaka
2	RUS	PETROV Vladislav
3	USA	MCDONOUGH Matt
3	MGL	BYAMBADORJ Khash-Erdene
5	MDA	CHIRTOACA Alexandru
5	UKR	BILEICHUK Petro
7	ISR	ZOBKOV Demitri
8	TUR	DAYLAK Ziya
9	BUL	FERAYM Mehmed
10	HUN	NYIRI Milan
11	KGZ	ISAKOV Imanbek

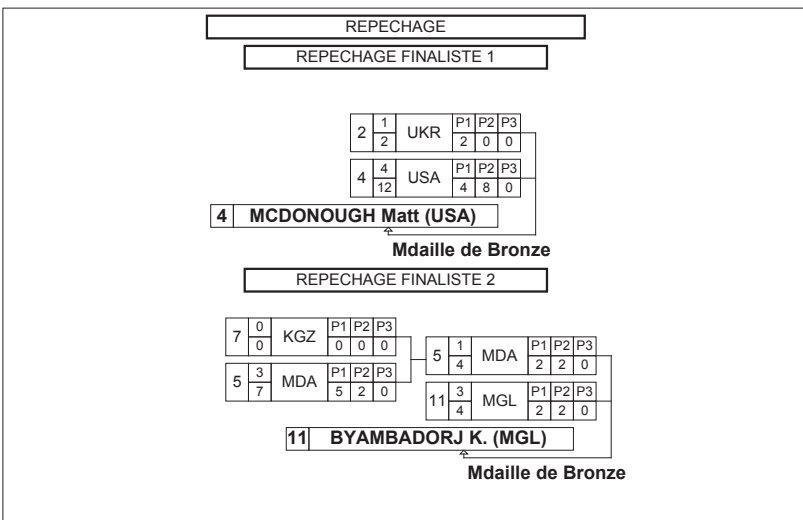



Classement

11th World University Wrestling Championship



STYLE : FS 57 kg

1 - Or / Gold



MORISHITA Fumitaka

2 - Argent / Silver



PETROV Vladislav

3 - Bronze



MCDONOUGH Matt



BYAMBADORJ Khash-Erdene

Classement	Nom - Name	Pays - Country
1	MORISHITA Fumitaka	JPN
2	PETROV Vladislav	RUS
3	MCDONOUGH Matt	USA
3	BYAMBADORJ K.	MGL
5	CHIRTOACA Alexandru	MDA
5	BILEICHUK Petro	UKR
7	ZOBKOV Demitri	ISR
8	DAYLAK Ziya	TUR
9	FERAYM Mehmed	BUL
10	NYIRI Milan	HUN
11	ISAKOV Imanbek	KGZ



# Feuille de compétition / Competition Sheet

## 11th World University Wrestling Championship



STYLE : FS 61 kg

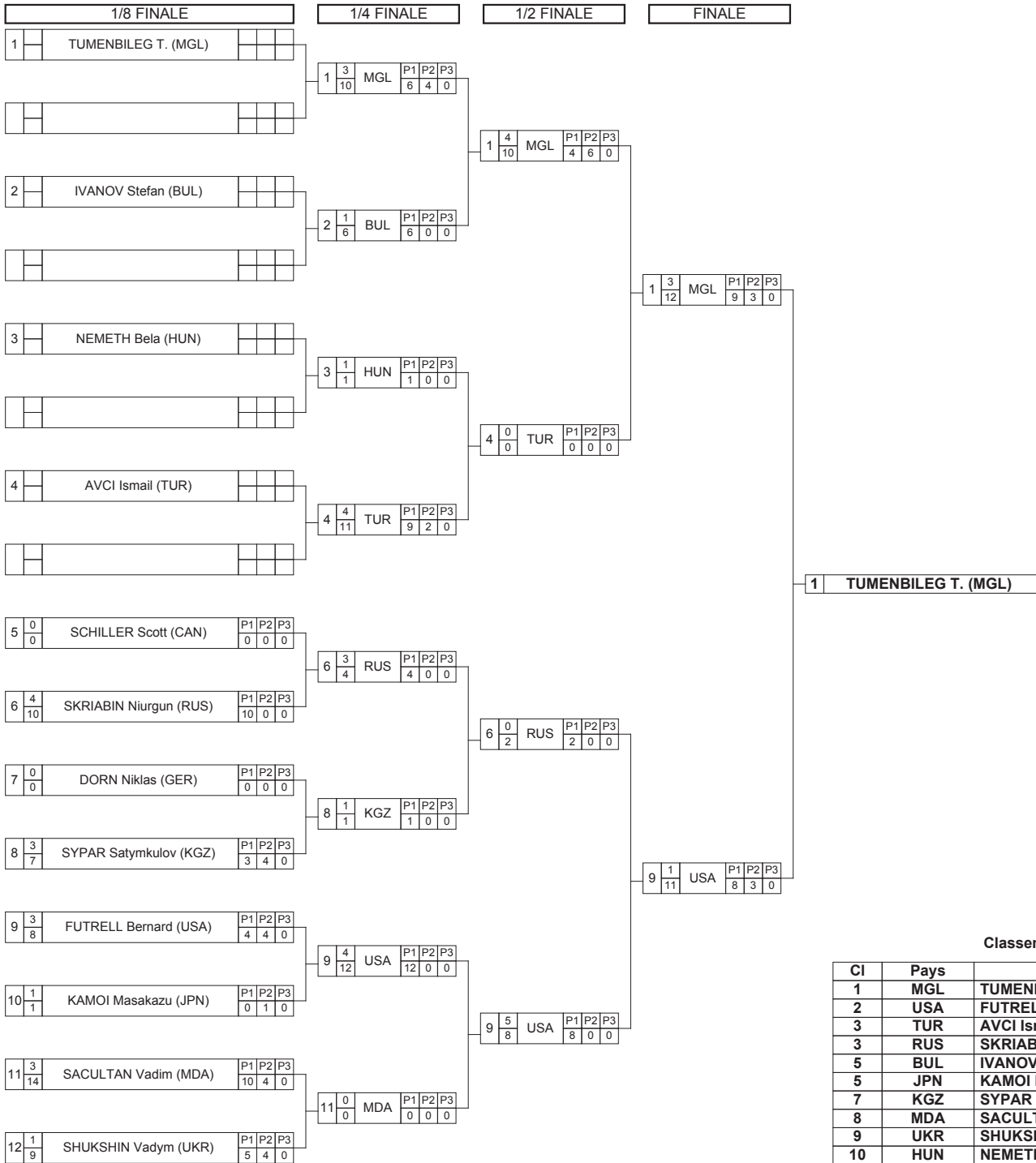

### Classement

Cl	Pays	Nom
1	MGL	TUMENBILEG Tuvshintulga
2	USA	FUTRELL Bernard
3	TUR	AVCI Ismail
3	RUS	SKRIABIN Niurgun
5	BUL	IVANOV Stefan
5	JPN	KAMOJ Masakazu
7	KGZ	SYPAR Satymkulov
8	MDA	SACULTAN Vadim
9	UKR	SHUKSHIN Vadym
10	HUN	NEMETH Bela
11	GER	DORN Niklas
12	CAN	SCHILLER Scott

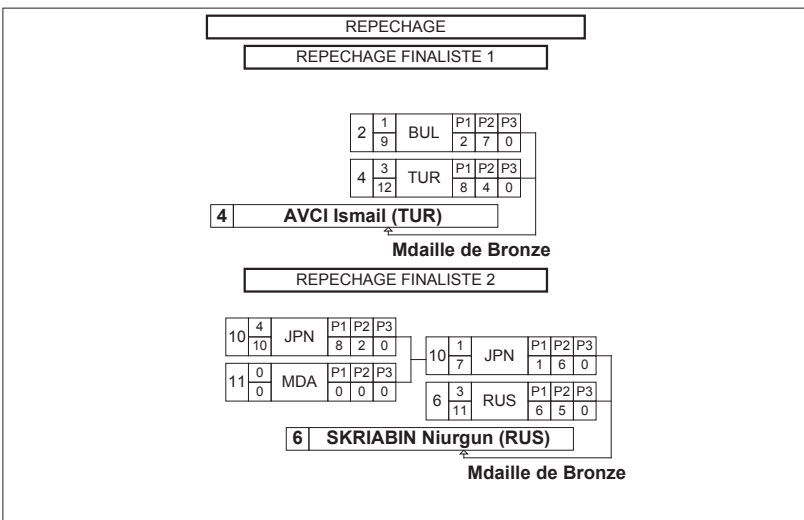



Classement

11th World University Wrestling Championship



STYLE : FS 61 kg

1 - Or / Gold



TUMENBILEG Tuvshintulga

2 - Argent / Silver



FUTRELL Bernard

3 - Bronze



AVCI Ismail



SKRIABIN Niurgun

Classement	Nom - Name	Pays - Country
1	TUMENBILEG T.	MGL
2	FUTRELL Bernard	USA
3	AVCI Ismail	TUR
3	SKRIABIN Niurgun	RUS
5	IVANOV Stefan	BUL
5	KAMOI Masakazu	JPN
7	SYPAR Satymkulov	KGZ
8	SACULTAN Vadim	MDA
9	SHUKSHIN Vadym	UKR
10	NEMETH Bela	HUN
11	DORN Niklas	GER
12	SCHILLER Scott	CAN



# Feuille de compétition / Competition Sheet

## 11th World University Wrestling Championship



STYLE : FS 65 kg



11 KILICSALLAYAN S. (TUR)

### Classement

Cl	Pays	Nom
1	TUR	KILICSALLAYAN Selahattin
2	ROU	BUCUR George
3	MGL	BATCHULUUN Batmagnai
3	MDA	SAVA Mihail
5	CAN	IWASA-MADGE Kevin
5	RUS	AKHMEDOV Ruslan
7	UKR	DUKHNO Vadym
8	BUL	BOYCHEV Boycho
9	JPN	SHINKAWA Takeya
10	USA	ASHNAULT Anthony
11	HUN	BABSZKY Gergely
11	SRB	POPOVIC Milan
13	ESP	PERMUY SOTO Eliseo

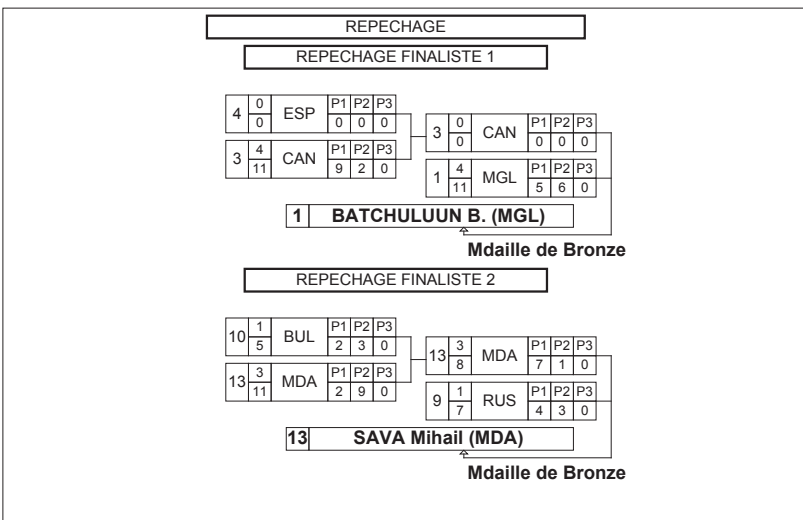





**Classement**

**11th World University Wrestling Championship**



STYLE : FS 65 kg

1 - Or / Gold



KILICSALLAYAN Selahattin

2 - Argent / Silver



BUCUR George

3 - Bronze



BATCHULUUN Batmagnai



SAVA Mihail

<i>Classement</i>	<i>Nom - Name</i>	<i>Pays - Country</i>
1	KILICSALLAYAN S.	TUR
2	BUCUR George	ROU
3	BATCHULUUN B.	MGL
3	SAVA Mihail	MDA
5	IWASA-MADGE Kevin	CAN
5	AKHMEDOV Ruslan	RUS
7	DUKHNO Vadym	UKR
8	BOYCHEV Boycho	BUL
9	SHINKAWA Takeya	JPN
10	ASHNAULT Anthony	USA
11	BABSZKY Gergely	HUN
11	POPOVIC Milan	SRB
13	PERMUY SOTO Eliseo	ESP



# Feuille de compétition / Competition Sheet

## 11th World University Wrestling Championship



STYLE : FS 70 kg

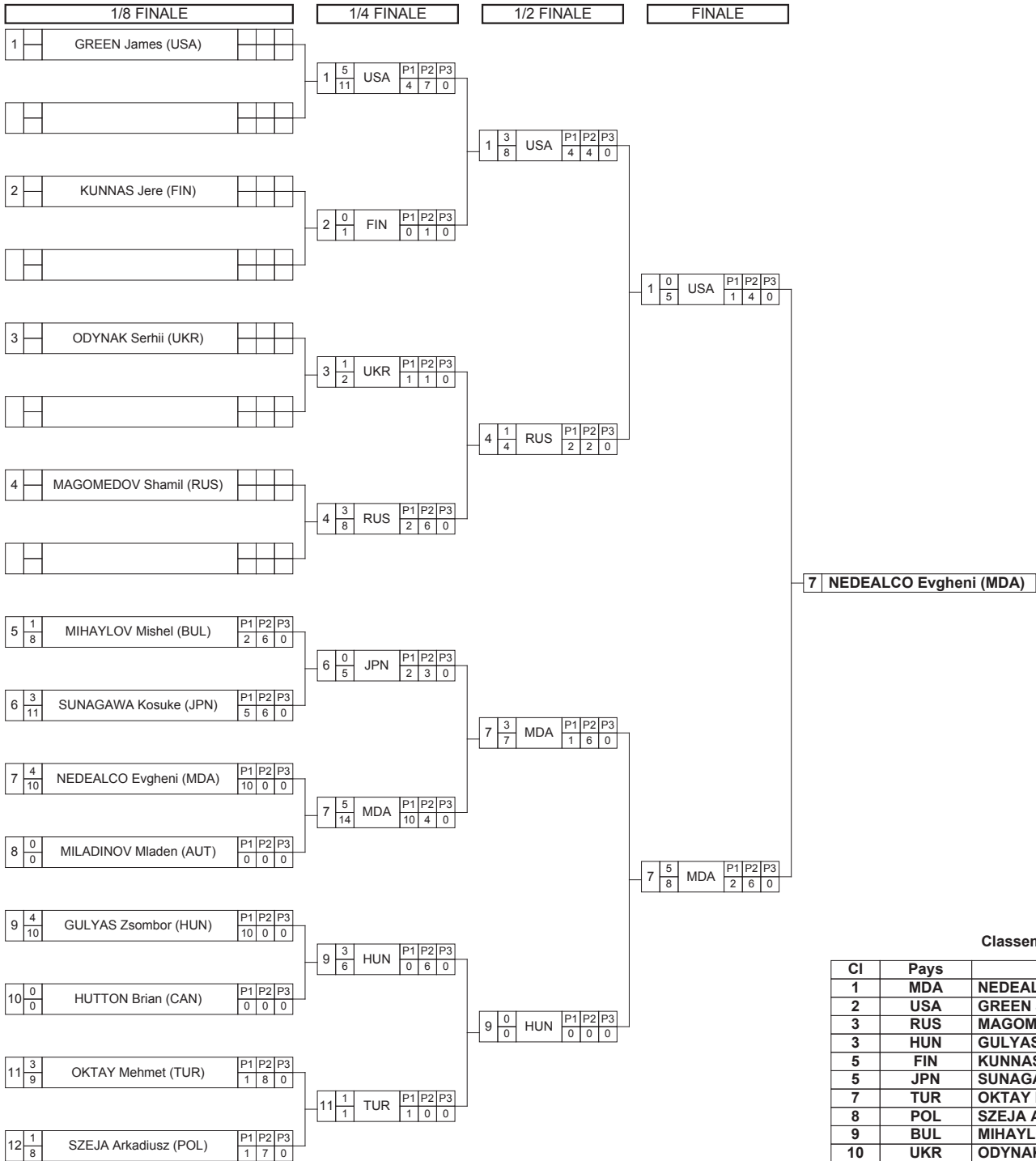

### Classement

Cl	Pays	Nom
1	MDA	NEDEALCO Evgheni
2	USA	GREEN James
3	RUS	MAGOMEDOV Shamil
3	HUN	GULYAS Zsombor
5	FIN	KUNNAS Jere
5	JPN	SUNAGAWA Kosuke
7	TUR	OKTAY Mehmet
8	POL	SZEJA Arkadiusz
9	BUL	MIHAYLOV Mishel
10	UKR	ODYNAK Serhii
11	CAN	HUTTON Brian
12	AUT	MILADINOV Mladen

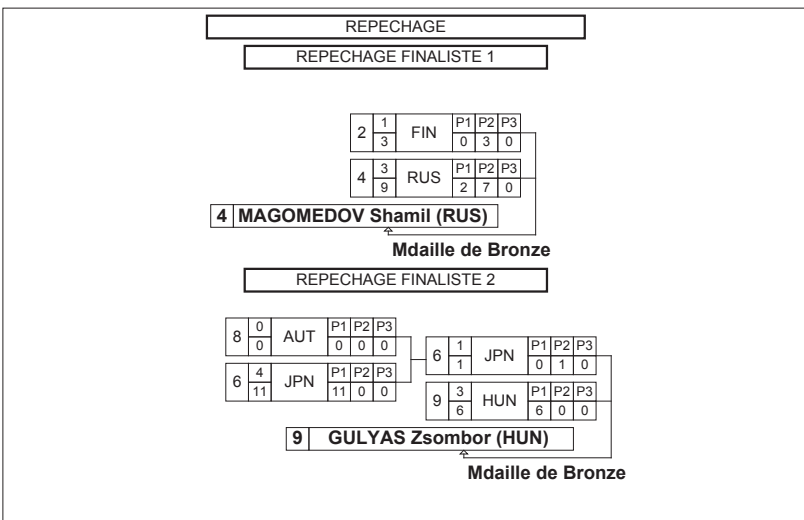



Classement

11th World University Wrestling Championship



STYLE : FS 70 kg

1 - Or / Gold



NEDEALCO Evgheni

2 - Argent / Silver



GREEN James

3 - Bronze



MAGOMEDOV Shamil



GULYAS Zsombor

Classement	Nom - Name	Pays - Country
1	NEDEALCO Evgheni	MDA
2	GREEN James	USA
3	MAGOMEDOV Shamil	RUS
3	GULYAS Zsombor	HUN
5	KUNNAS Jere	FIN
5	SUNAGAWA Kosuke	JPN
7	OKTAY Mehmet	TUR
8	SZEJA Arkadiusz	POL
9	MIHAYLOV Mishel	BUL
10	ODYNAK Serhii	UKR
11	HUTTON Brian	CAN
12	MILADINOV Mladen	AUT



# Feuille de compétition / Competition Sheet

## 11th World University Wrestling Championship



STYLE : FS 74 kg



13 CALDWELL Tyler (USA)

### Classement

Cl	Pays	Nom
1	USA	CALDWELL Tyler
2	RUS	OSMANOV Shamil-Imam
3	TUR	GURBUZ Musa
3	UKR	NAGORNYI Andrii
5	KGZ	ILGIZ Dzhakypbekov
5	SVK	OLLE Robert
7	CAN	DAYE-FINLEY Shawn
8	POL	SOKALSKI Andrzej
9	ROU	ATOFANI Marius Lucian
10	JPN	KITAMURA Kohei
11	GER	HAST Alexander
12	MDA	VASILACHI Ion
13	BUL	MOLLA Hasan
14	BRA	GABRIEL RENNO MARTINEZ Sandro
15	HUN	LAGZI KOVACS Bendeguz

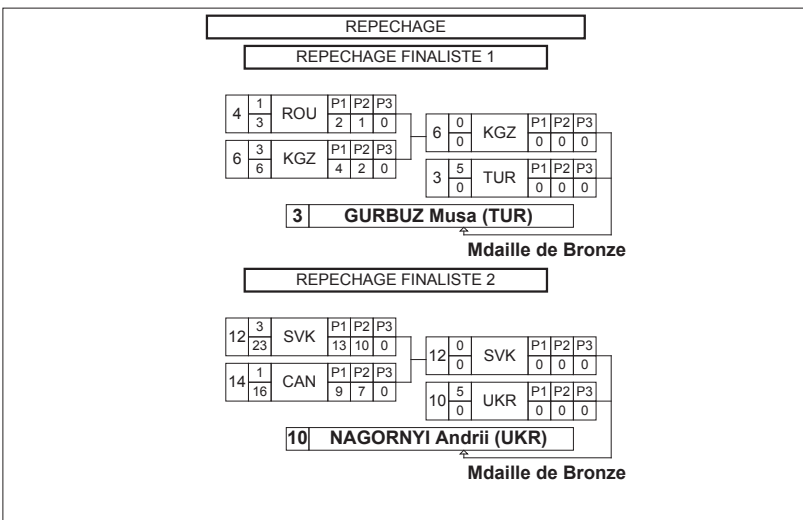



Classement

11th World University Wrestling Championship



STYLE : FS 74 kg

1 - Or / Gold



CALDWELL Tyler

2 - Argent / Silver



OSMANOV Shamil-Imam

3 - Bronze



GURBUZ Musa



NAGORNYI Andrii

Classement	Nom - Name	Pays - Country
1	CALDWELL Tyler	USA
2	OSMANOV Shamil-Imam	RUS
3	GURBUZ Musa	TUR
3	NAGORNYI Andrii	UKR
5	ILGIZ Dzhakypbekov	KGZ
5	OLLE Robert	SVK
7	DAYE-FINLEY Shawn	CAN
8	SOKALSKI Andrzej	POL
9	ATOFANI M.	ROU
10	KITAMURA Kohei	JPN
11	HAST Alexander	GER
12	VASILACHI Ion	MDA
13	MOLLA Hasan	BUL
14	GABRIEL RENNO MARTINEZ S.	BRA
15	LAGZI KOVACS B.	HUN



# Feuille de compétition / Competition Sheet

## 11th World University Wrestling Championship



STYLE : FS 86 kg



8 IANULOV Piotr (MDA)

### Classement

Cl	Pays	Nom
1	MDA	IANULOV Piotr
2	USA	PERRY Chris
3	ISR	BERNSTEIN Ophir
3	TUR	KORKMAZ Namik
5	RUS	KTSOEV Oleg
5	HUN	TOZSER Sandor
7	POL	JEZIERZANSKI Sebastian
8	JPN	AKAGUMA Naoya
9	SVK	BODNĀ•R Michael
10	KGZ	AIBEK Usupov
10	CAN	OTTO Riley
12	FIN	HEINO Ville
13	ROU	FRANT Andrei Victor
14	UKR	CHUIEV Anton
15	BUL	YURUKOV Iren
16	BRA	MAIA DA NOBREGA Jonatas Augustus

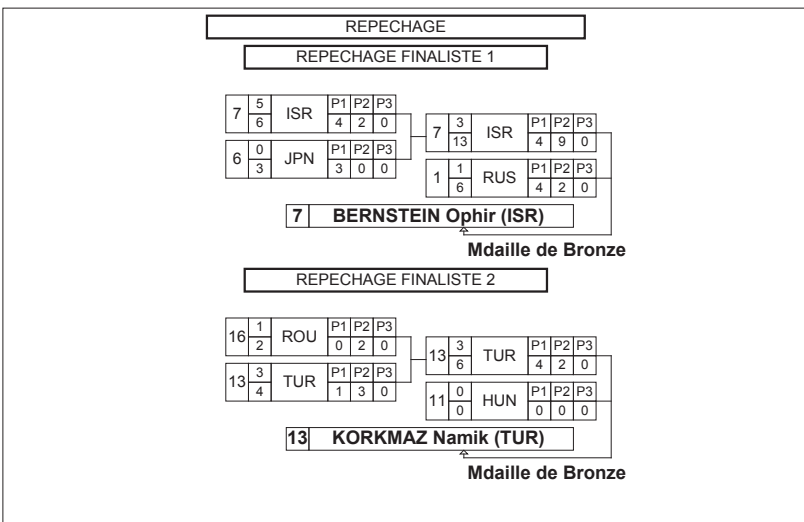



**Classement**

**11th World University Wrestling Championship**



STYLE : FS 86 kg

1 - Or / Gold



IANULOV Piotr

2 - Argent / Silver



PERRY Chris

3 - Bronze



BERNSTEIN Ophir



KORKMAZ Namik

<i>Classement</i>	<i>Nom - Name</i>	<i>Pays - Country</i>
1	IANULOV Piotr	MDA
2	PERRY Chris	USA
3	BERNSTEIN Ophir	ISR
3	KORKMAZ Namik	TUR
5	KTSOEV Oleg	RUS
5	TOZSER Sandor	HUN
7	JEZIERZANSKI S.	POL
8	AKAGUMA Naoya	JPN
9	BODNÁR Michael	SVK
10	AIBEK Usupov	KGZ
10	OTTO Riley	CAN
12	HEINO Ville	FIN
13	FRANT Andrei Victor	ROU
14	CHUIEV Anton	UKR
15	YURUKOV Iren	BUL
16	MAIA DA NOBREGA J.	BRA



# Feuille de compétition / Competition Sheet

## 11th World University Wrestling Championship



STYLE : FS 97 kg

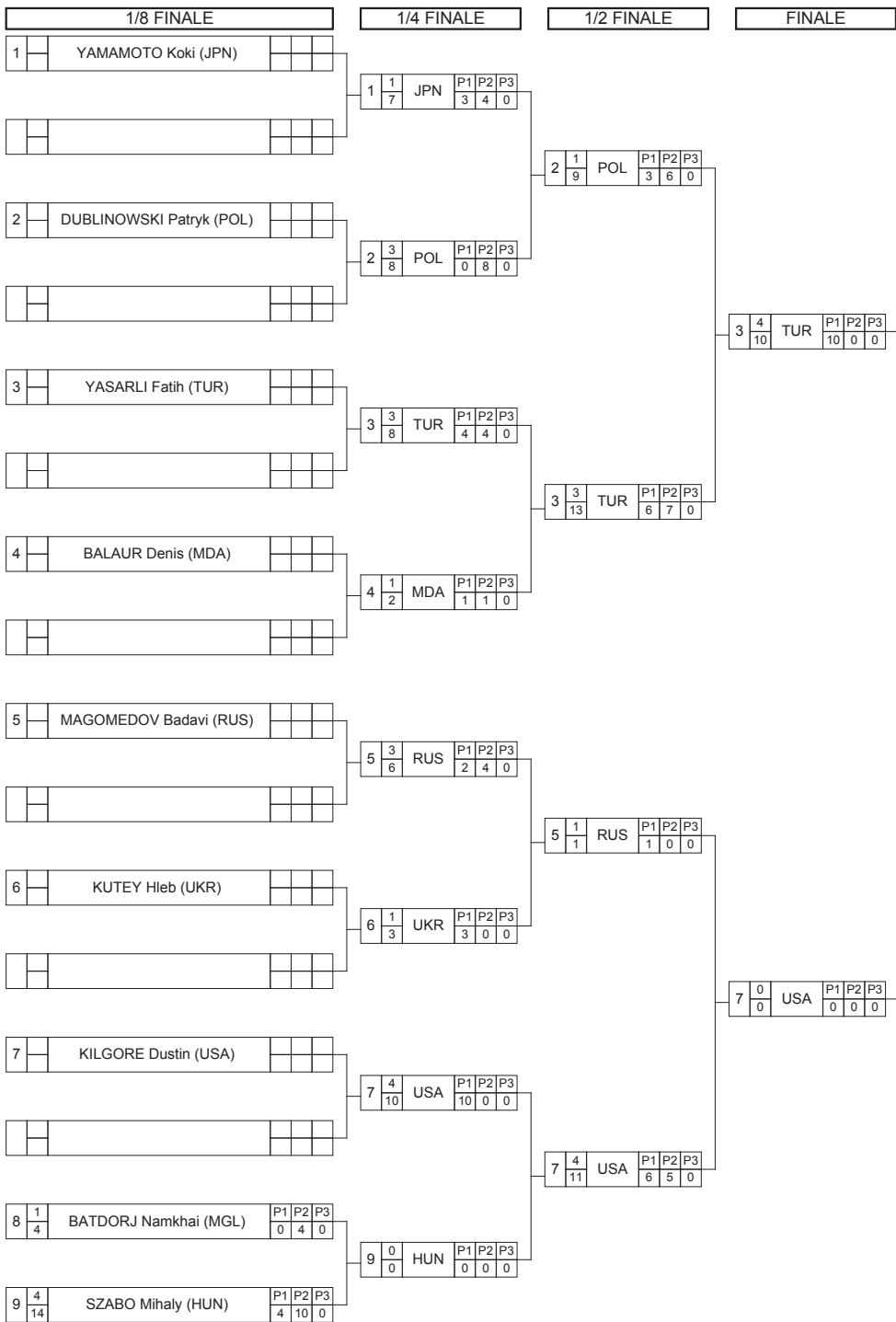

3 YASARLI Fatih (TUR)

Classement

Cl	Pays	Nom
1	TUR	YASARLI Fatih
2	USA	KILGORE Dustin
3	POL	DUBLINOWSKI Patryk
3	HUN	SZABO Mihaly
5	MDA	BALAUUR Denis
5	RUS	MAGOMEDOV Badavi
7	JPN	YAMAMOTO Koki
8	MGL	BATDORJ Namkhai
9	UKR	KUTEY Hleb

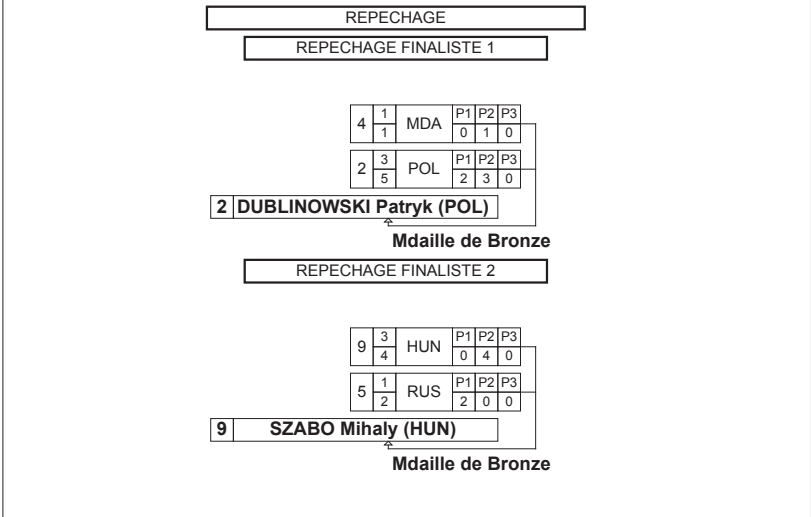





Classement

11th World University Wrestling Championship



STYLE : FS 97 kg

1 - Or / Gold



YASARLI Fatih

2 - Argent / Silver



KILGORE Dustin

3 - Bronze



DUBLINOWSKI Patryk



SZABO Mihaly

Classement	Nom - Name	Pays - Country
1	YASARLI Fatih	TUR
2	KILGORE Dustin	USA
3	DUBLINOWSKI Patryk	POL
3	SZABO Mihaly	HUN
5	BALAUER Denis	MDA
5	MAGOMEDOV Badavi	RUS
7	YAMAMOTO Koki	JPN
8	BATDORJ Namkhai	MGL
9	KUTEY Hleb	UKR



# 11TH WORLD UNIVERSITY WRESTLING CHAMPIONSHIP



PECS (HUN)

2014-07-07 - 2014-07-12 2014

Résultats - Results

Lutte Féminine - Female-Wrestling





Liste des arbitres / Referee list

11th World University Wrestling Championship



<i>N°</i>	<i>Licence</i>	<i>Pays Country</i>	<i>Nom - Last Name</i>	<i>Prénom - First Name</i>
-----------	----------------	-------------------------	------------------------	----------------------------





Liste des nations / Countries List

11th World University Wrestling Championship

STYLE FW



*Pays - Country*

	BRAZIL	BRA
	BULGARIA	BUL
	CANADA	CAN
	ESTONIA	EST
	FINLAND	FIN
	GERMANY	GER
	HUNGARY	HUN
	JAPAN	JPN
	MOLDOVA	MDA
	MONGOLIA	MGL
	POLAND	POL
	ROMANIA	ROU
	RUSSIA	RUS
	SLOVAKIA	SVK
	SPAIN	ESP
	SWITZERLAND	SUI
	UKRAINE	UKR
	UNITED STATES	USA

Nombre de nations - Number of Countries 18

**Nombre d'engagés par nation / Number of Entries By Country****11th World University Wrestling Championship****STYLE FW**

<b>Pays - Country</b>	<b>48 KG</b>	<b>53 KG</b>	<b>55 KG</b>	<b>58 KG</b>	<b>60 KG</b>	<b>63 KG</b>	<b>69 KG</b>	<b>75 KG</b>	<b>TOTAL</b>
BRA				1					1
BUL	1		1			1			3
CAN	1	1	1	1	1	1	1	1	8
ESP								1	1
EST								1	1
FIN			1						1
GER							1		1
HUN	1		1	1	1	1			5
JPN	1	1	1	1	1	1	1	1	8
MDA	1	1		1					3
MGL	1				1	1			3
POL	1	1		1		1	1	1	6
ROU	1						1		2
RUS	1	1	1	1	1	1	1	1	8
SUI		1							1
SVK	1								1
UKR	1	1	1	1	1	1	1	1	8
USA	1	1	1	1	1	1	1	1	8
<b>TOTAL</b>	<b>12</b>	<b>8</b>	<b>8</b>	<b>9</b>	<b>7</b>	<b>9</b>	<b>8</b>	<b>8</b>	<b>69</b>

**Nombre de nations - Number of Countries** **18**



Liste des Engagés par pays / Entry-List By Country

11th World University Wrestling Championship

STYLE FW



**BRAZIL (BRA)**

Lutteuse(s) / Wrestler(s) :

58 kg RODRIGUES CAMPOS JULHO, Josimara

**BULGARIA (BUL)**

Lutteuse(s) / Wrestler(s) :

48 kg DIMITROVA, Pepa  
55 kg NIKOLOVA, Evelina  
63 kg MANOLOVA, Dzanan

**CANADA (CAN)**

Lutteuse(s) / Wrestler(s) :

48 kg MIAN, Jasmine  
53 kg BARRY, Brianne  
55 kg STEWART, Samantha  
58 kg MILOVITCH-SERA, Elizabeth  
60 kg CONTANTE-RODRIGUES, Celeste  
63 kg LAPPAGE, Danielle  
69 kg YEATS, Dorothy  
75 kg WIEBE, Erica

**ESTONIA (EST)**

Lutteuse(s) / Wrestler(s) :

75 kg MAE, Epp

**FINLAND (FIN)**

Lutteuse(s) / Wrestler(s) :

55 kg VAINIONPAA, Tiina

**GERMANY (GER)**

Lutteuse(s) / Wrestler(s) :

69 kg HUG, Lisa Nadine

**HUNGARY (HUN)**



## Liste des Engagés par pays / Entry-List By Country

### 11th World University Wrestling Championship



STYLE FW

#### Lutteuse(s) / Wrestler(s) :

48 kg	MIHALOVICS, Ivett
55 kg	KOROSI, Eva
58 kg	BARKA, Emese
60 kg	JAGER, Szimonetta
63 kg	SLEISZ, Gabriella

#### JAPAN (JPN)

#### Lutteuse(s) / Wrestler(s) :

48 kg	ITO, Shiori
53 kg	TANAKA, Arisa
55 kg	HAMADA, Chiho
58 kg	HIGUCHI, Mikako
60 kg	HAYAMI, Natsumi
63 kg	UEHARA, Haruna
69 kg	HASHIMOTO, Chihiro
75 kg	YOSHII, Tamae

#### MOLDOVA (MDA)

#### Lutteuse(s) / Wrestler(s) :

48 kg	BUDEANU, Emilia
53 kg	LEORDA, Iulia
58 kg	RUSU, Ecaterina

#### MONGOLIA (MGL)

#### Lutteuse(s) / Wrestler(s) :

48 kg	TSOGTBAATAR, Tsendjav
60 kg	SANDAGDORJ, Narantsetseg
63 kg	OTGONBAT, Oyuntuya

#### POLAND (POL)

#### Lutteuse(s) / Wrestler(s) :

48 kg	LUKASIAK, Anna
53 kg	JEZIERZANSKA, Sara
58 kg	MICHALAK, Katarzyna
63 kg	KROL, Agnieszka





Liste des Engagés par pays / Entry-List By Country

11th World University Wrestling Championship



STYLE FW

69 kg OSOCCA, Daria  
75 kg HOWIS, Patrycja

**ROMANIA (ROU)**

**Lutteuse(s) / Wrestler(s) :**

48 kg LINGURARU, Madalina  
69 kg POPESCU, Adina-Elena

**RUSSIA (RUS)**

**Lutteuse(s) / Wrestler(s) :**

48 kg MOREVA, Alina  
53 kg ORSHUSH, Stalvira  
55 kg OLOGONOVA, Irina  
58 kg NAGORNYKH, Oksana  
60 kg LIULKOVA, Mariia  
63 kg LAZINSKAIA, Valeriia  
69 kg SANZHEEVA, Darima  
75 kg FROLOVA, Viktoriya

**SLOVAKIA (SVK)**

**Lutteuse(s) / Wrestler(s) :**

48 kg MATEJOVA, Lenka

**SPAIN (ESP)**

**Lutteuse(s) / Wrestler(s) :**

75 kg LALIN CANDIA, Noelia

**SWITZERLAND (SUI)**

**Lutteuse(s) / Wrestler(s) :**

53 kg RIESER, Nathalie

**UKRAINE (UKR)**

**Lutteuse(s) / Wrestler(s) :**

48 kg RYBAK, Iryna



Liste des Engagés par pays / Entry-List By Country

11th World University Wrestling Championship



STYLE FW

53 kg	SHNAIDER, Olga
55 kg	KIT, Tetyana
58 kg	LAVRECHUK, Tetyana
60 kg	CHPURKO, Viktoriia
63 kg	MALYK, Yulija
69 kg	MOSPAN, Maryna
75 kg	TELKOVA, Ganna

**UNITED STATES (USA)**

**Lutteuse(s) / Wrestler(s) :**

48 kg	GOLSTON, Erin
53 kg	FEARNSIDE, Amy
55 kg	KLINGEL, Samantha
58 kg	WINCHESTER, Jacarra
60 kg	DELGADO, Brieana
63 kg	HENDEY, Amanda
69 kg	MENSAH, Tamyra
75 kg	SALATA, Julia



# Feuille de compétition / Competition Sheet

## 11th World University Wrestling Championship



STYLE : FW 48 kg

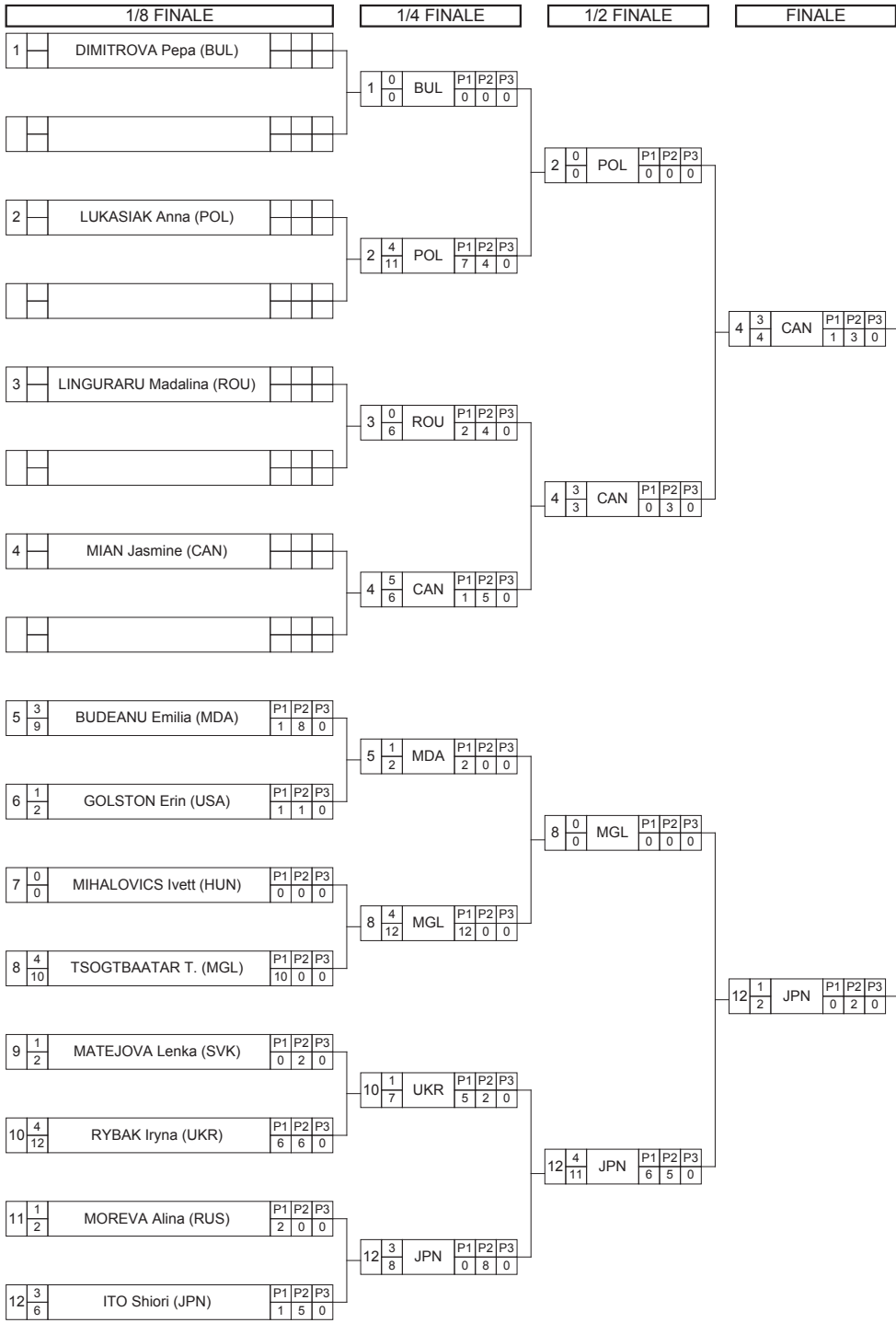

Classement

Cl	Pays	Nom
1	CAN	MIAN Jasmine
2	JPN	ITO Shiori
3	POL	LUKASIAK Anna
3	RUS	MOREVA Alina
5	ROU	LINGURARU Madalina
5	MGL	TSOGTBAATAR Tsendjav
7	UKR	RYBAK Iryna
8	MDA	BUDEANU Emilia
9	USA	GOLSTON Erin
10	SVK	MATEJOVA Lenka
11	HUN	MIHALOVICS Ivett
12	BUL	DIMITROVA Pepa

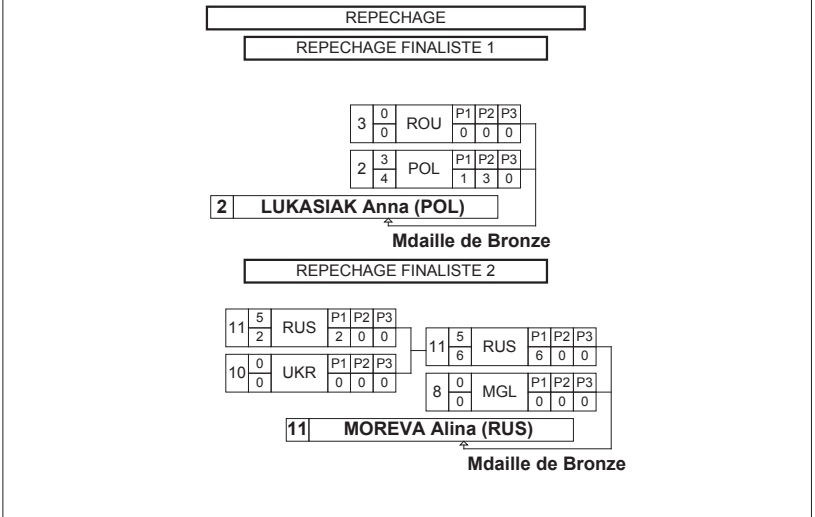



**Classement**

**11th World University Wrestling Championship**



STYLE : FW 48 kg

1 - Or / Gold



MIAN Jasmine

2 - Argent / Silver



ITO Shiori

3 - Bronze



LUKASIAK Anna



MOREVA Alina

<i>Classement</i>	<i>Nom - Name</i>	<i>Pays - Country</i>
1	MIAN Jasmine	CAN
2	ITO Shiori	JPN
3	LUKASIAK Anna	POL
3	MOREVA Alina	RUS
5	LINGURARU Madalina	ROU
5	TSOGTBAATAR T.	MGL
7	RYBAK Iryna	UKR
8	BUDEANU Emilia	MDA
9	GOLSTON Erin	USA
10	MATEJOVA Lenka	SVK
11	MIHALOVICS Ivett	HUN
12	DIMITROVA Pepa	BUL



# Feuille de compétition / Competition Sheet

## 11th World University Wrestling Championship



STYLE : FW 53 kg

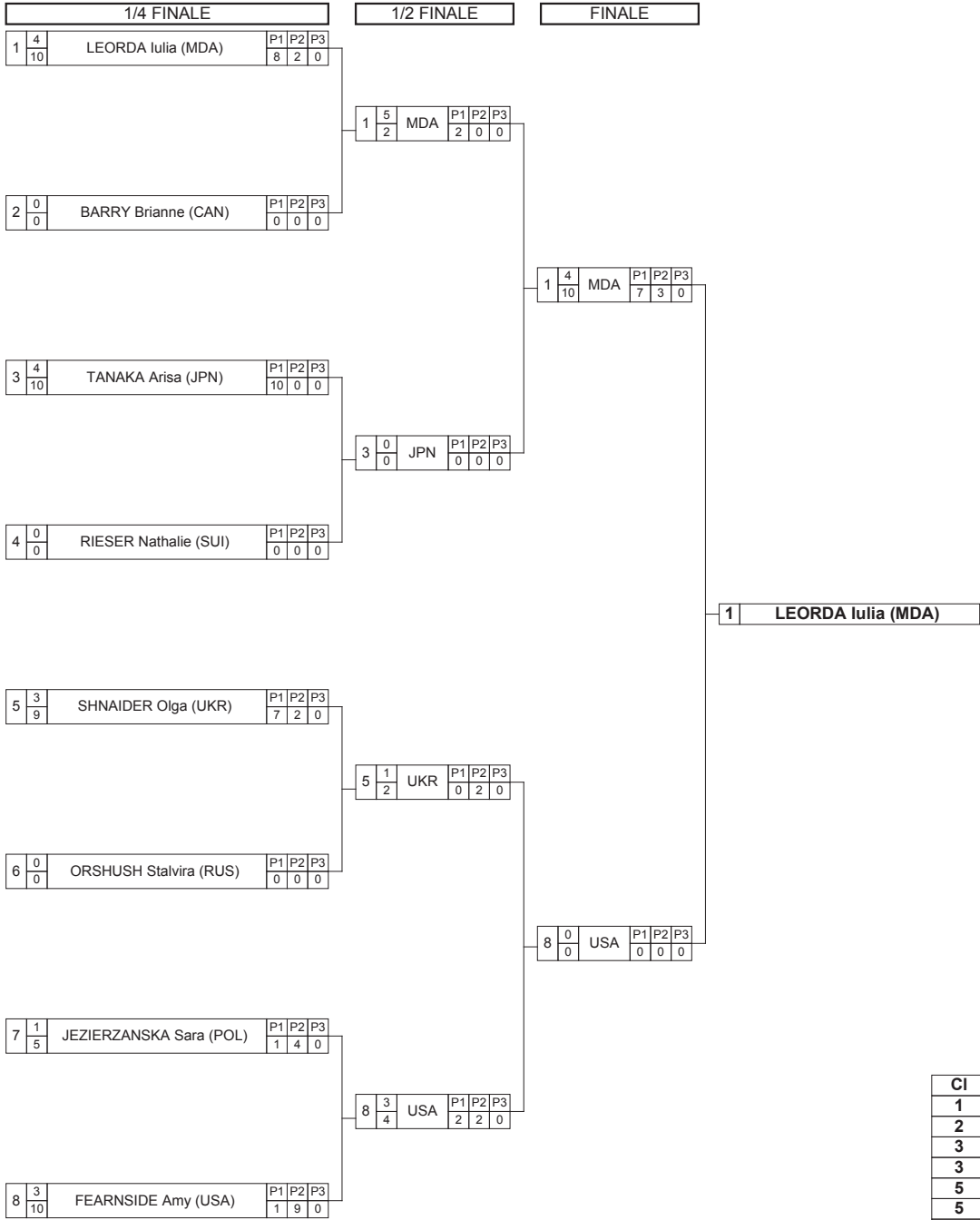

Classement

Cl	Pays	Nom
1	MDA	LEORDA Iulia
2	USA	FEARNSIDE Amy
3	JPN	TANAKA Arisa
3	UKR	SHNAIDER Olga
5	CAN	BARRY Brianne
5	POL	JEZIERZANSKA Sara
7	RUS	ORSHUSH Stalvira
8	SUI	RIESER Nathalie

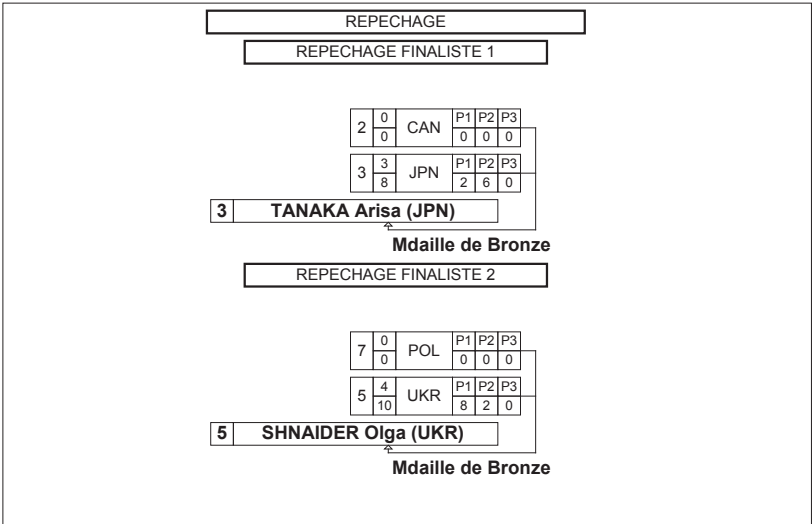



**Classement**

**11th World University Wrestling Championship**



STYLE : FW 53 kg

1 - Or / Gold



LEORDA Iulia

2 - Argent / Silver



FEARNSIDE Amy

3 - Bronze



TANAKA Arisa



SHNAIDER Olga

<i>Classement</i>	<i>Nom - Name</i>	<i>Pays - Country</i>
1	LEORDA Iulia	MDA
2	FEARNSIDE Amy	USA
3	TANAKA Arisa	JPN
3	SHNAIDER Olga	UKR
5	BARRY Brianne	CAN
5	JEZIERZANSKA Sara	POL
7	ORSHUSH Stalvira	RUS
8	RIESER Nathalie	SUI



# Feuille de compétition / Competition Sheet

## 11th World University Wrestling Championship



STYLE : FW 55 kg

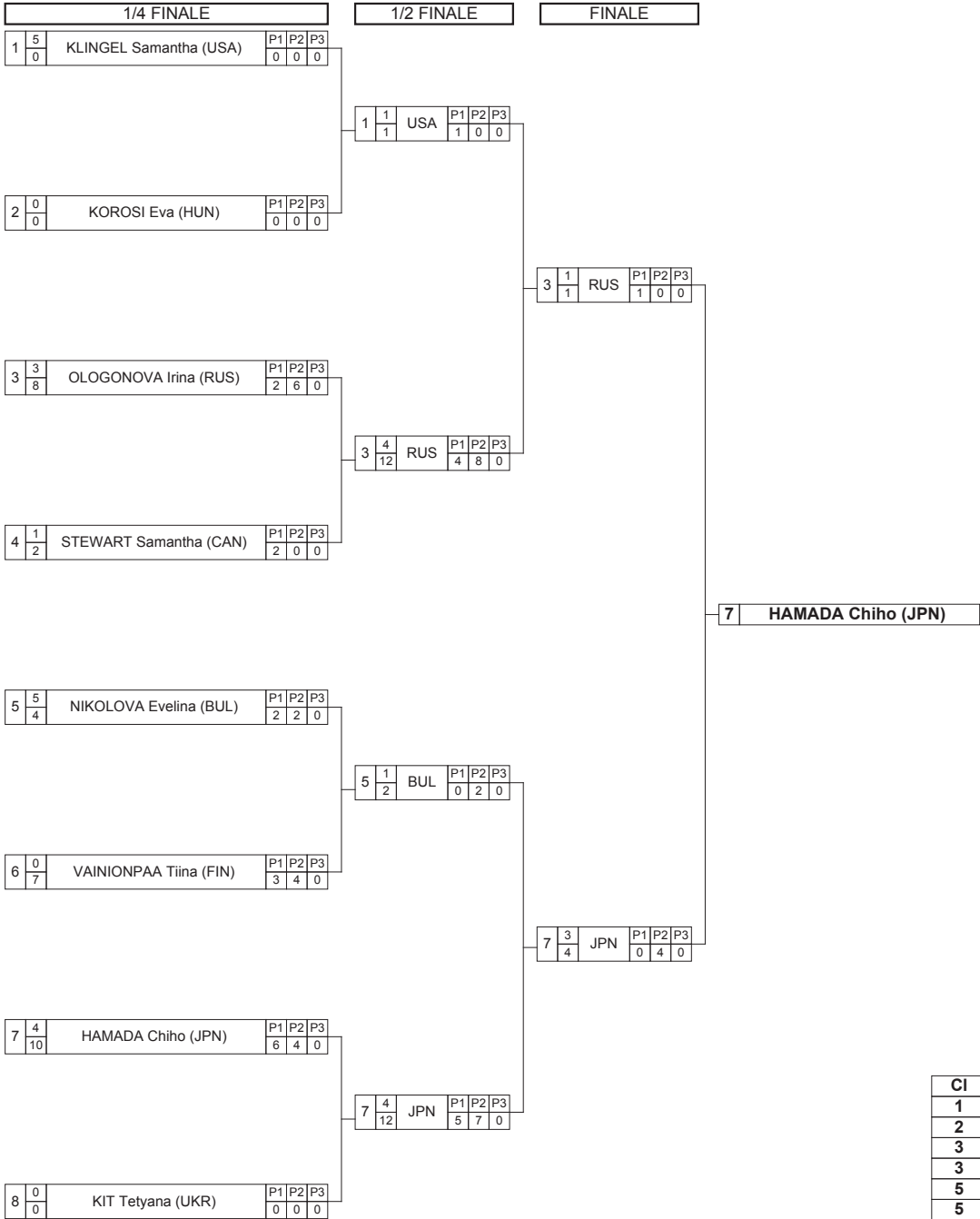

Classement

Cl	Pays	Nom
1	JPN	HAMADA Chiho
2	RUS	OLOGONOVA Irina
3	CAN	STEWART Samantha
3	UKR	KIT Tetyana
5	USA	KLINGEL Samantha
5	BUL	NIKOLOVA Evelina
7	FIN	VAINIONPAA Tiina
8	HUN	KOROSI Eva

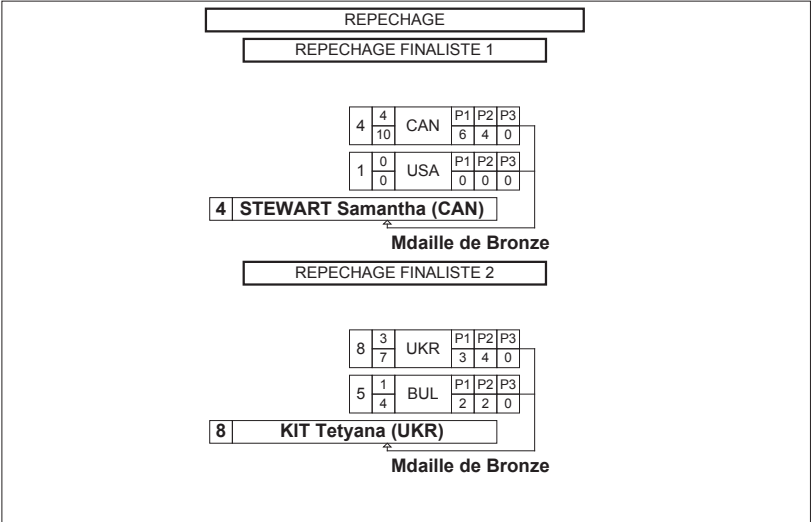



**Classement**

**11th World University Wrestling Championship**



STYLE : FW 55 kg

1 - Or / Gold



HAMADA Chiho

2 - Argent / Silver



OLOGONOVA Irina

3 - Bronze



STEWART Samantha



KIT Tetyana

<i>Classement</i>	<i>Nom - Name</i>	<i>Pays - Country</i>
1	HAMADA Chiho	JPN
2	OLOGONOVA Irina	RUS
3	STEWART Samantha	CAN
3	KIT Tetyana	UKR
5	KLINGEL Samantha	USA
5	NIKOLOVA Evelina	BUL
7	VAINIONPAA Tiina	FIN
8	KOROSI Eva	HUN





# Feuille de compétition / Competition Sheet

## 11th World University Wrestling Championship



STYLE : FW 58 kg

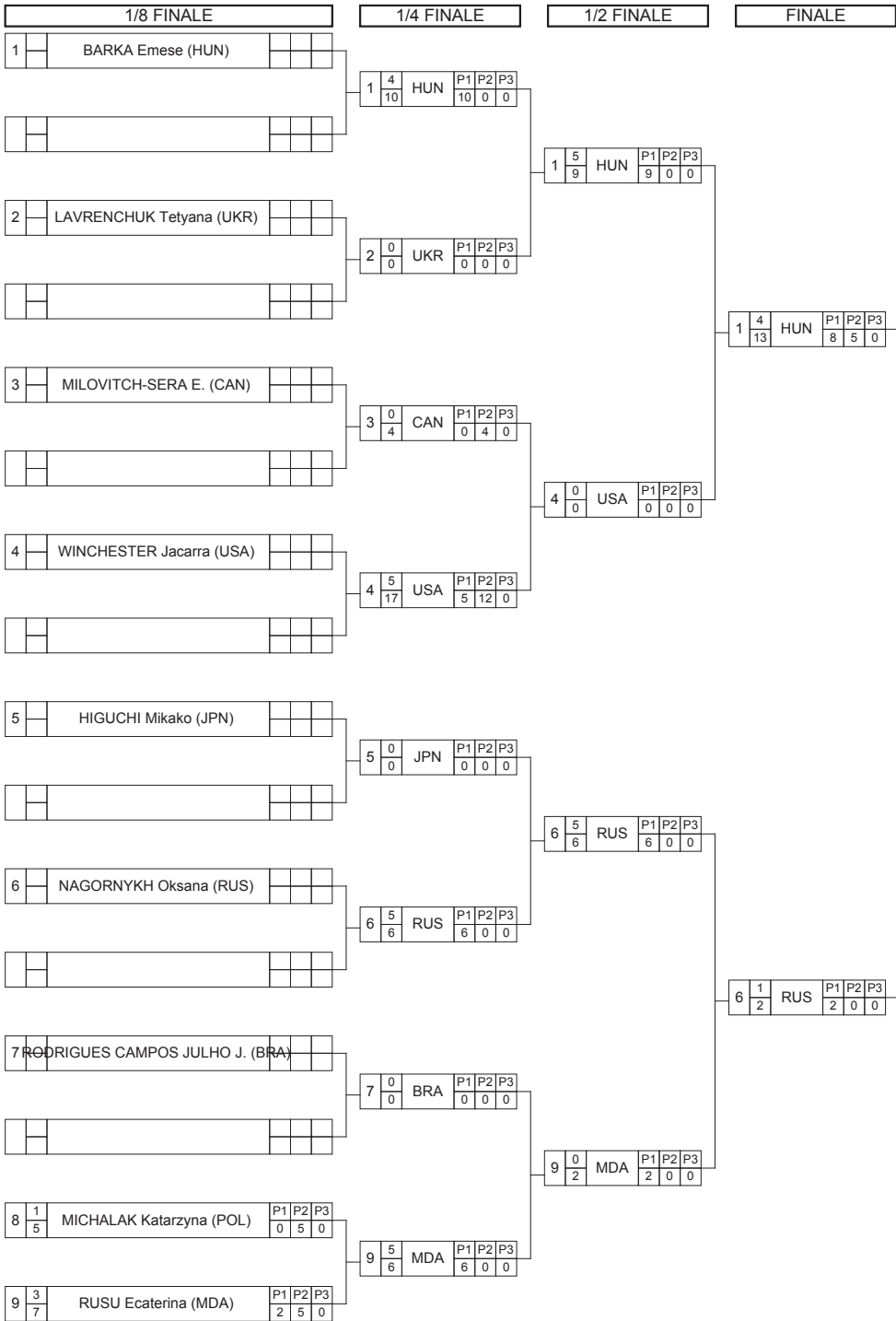

1 BARKA Emese (HUN)

Classement

Cl	Pays	Nom
1	HUN	BARKA Emese
2	RUS	NAGORNYKH Oksana
3	USA	WINCHESTER Jacarra
3	JPN	HIGUCHI Mikako
5	UKR	LAVRECHUK Tetyana
5	MDA	RUSU Ecaterina
7	POL	MICHALAK Katarzyna
8	CAN	MILOVITCH-SERA Elizabeth
9	BRA	RODRIGUES CAMPOS JULHO Josim

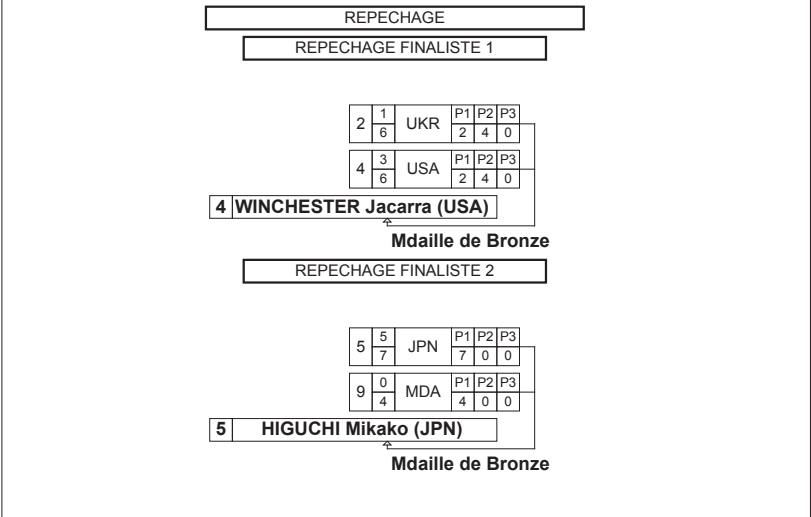



**Classement**

**11th World University Wrestling Championship**



STYLE : FW 58 kg

1 - Or / Gold



BARKA Emese

2 - Argent / Silver



NAGORNYKH Oksana

3 - Bronze



WINCHESTER Jacarra



HIGUCHI Mikako

<i>Classement</i>	<i>Nom - Name</i>	<i>Pays - Country</i>
1	BARKA Emese	HUN
2	NAGORNYKH Oksana	RUS
3	WINCHESTER Jacarra	USA
3	HIGUCHI Mikako	JPN
5	LAVRECHUK Tetyana	UKR
5	RUSU Ecaterina	MDA
7	MICHALAK Katarzyna	POL
8	MILOVITCH-SERA E.	CAN
9	RODRIGUES CAMPOS JULHO J.	BRA



# Feuille de compétition / Competition Sheet

## 11th World University Wrestling Championship



STYLE : FW 60 kg

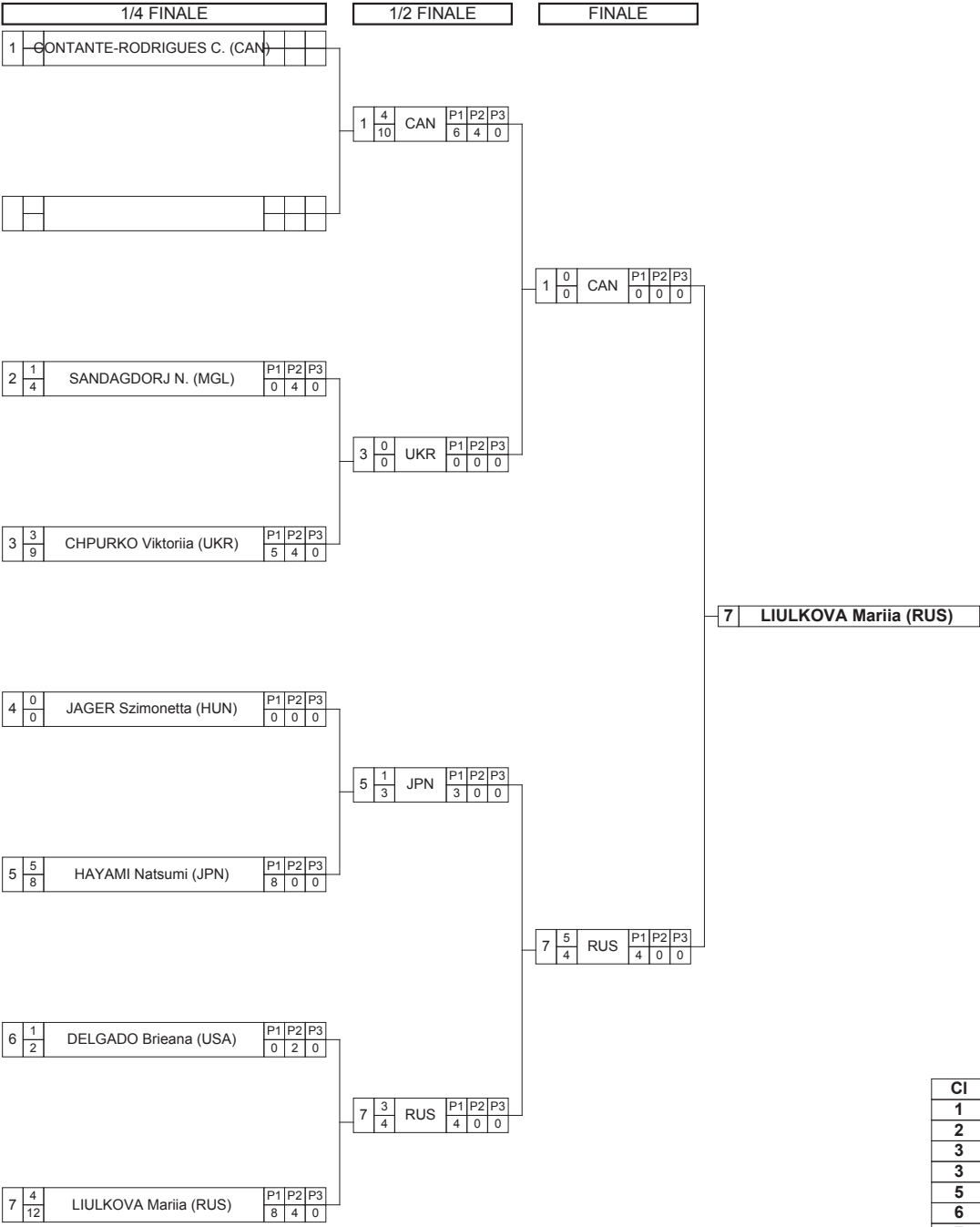

Classement

Cl	Pays	Nom
1	RUS	LIULKOVA Mariia
2	CAN	CONTANTE-RODRIGUES Celeste
3	UKR	CHPURKO Viktoriia
3	USA	DELGADO Brieana
5	JPN	HAYAMI Natsumi
6	MGL	SANDAGDORJ Narantsetseg
7	HUN	JAGER Szimonetta

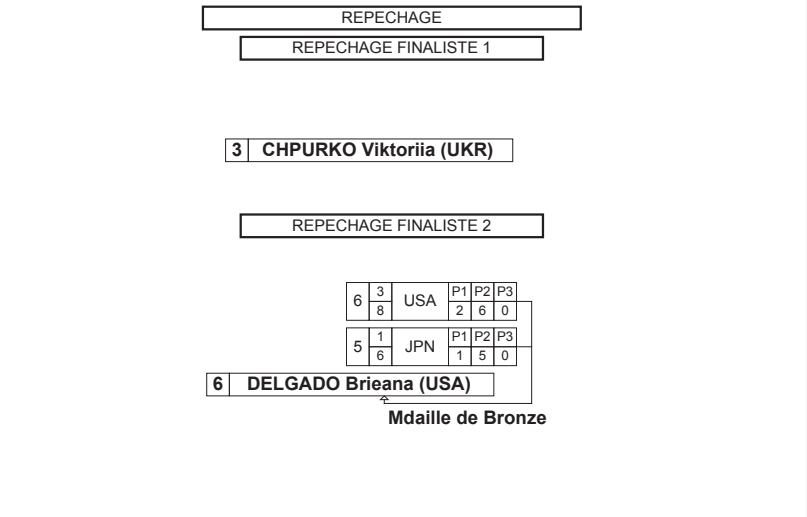



**Classement**

**11th World University Wrestling Championship**



STYLE : FW 60 kg

**1 - Or / Gold**



LIULKOVA Mariia

**2 - Argent / Silver**



CONTANTE-RODRIGUES Celeste

**3 - Bronze**



CHPURKO Viktoriia



DELGADO Briana

<i>Classement</i>	<i>Nom - Name</i>	<i>Pays - Country</i>
1	LIULKOVA Mariia	RUS
2	CONTANTE-RODRIGUES C.	CAN
3	CHPURKO Viktoriia	UKR
3	DELGADO Briana	USA
5	HAYAMI Natsumi	JPN
6	SANDAGDORJ N.	MGL
7	JAGER Szimonetta	HUN



# Feuille de compétition / Competition Sheet

## 11th World University Wrestling Championship



STYLE : FW 63 kg

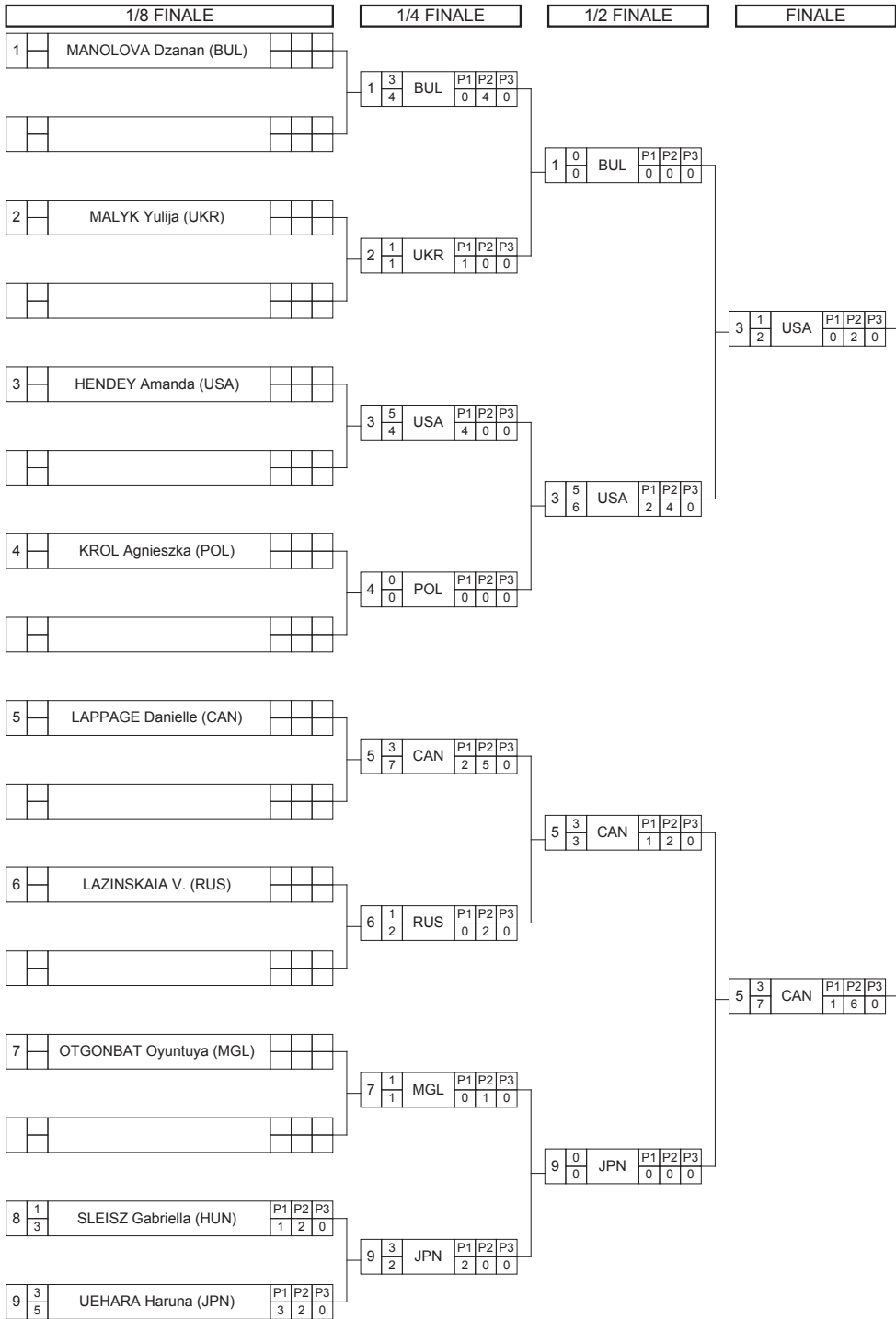

5 LAPPAGE Danielle (CAN)

Classement

Cl	Pays	Nom
1	CAN	LAPPAGE Danielle
2	USA	HENDEY Amanda
3	POL	KROL Agnieszka
3	RUS	LAZINSKAIA Valeriia
5	BUL	MANOLOVA Dzanan
5	JPN	UEHARA Haruna
7	HUN	SLEISZ Gabriella
8	MGL	OTGONBAT Oyuntuya
9	UKR	MALYK Yulija

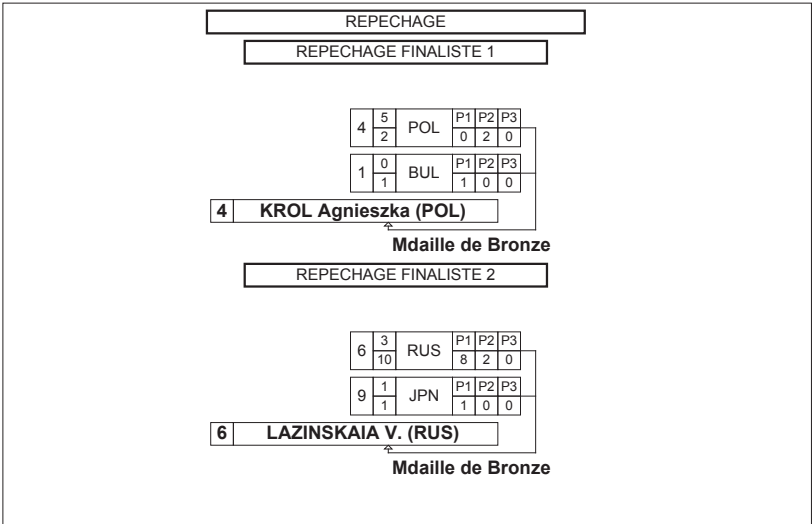



## Classement

### 11th World University Wrestling Championship



STYLE : FW 63 kg

1 - Or / Gold



LAPPAGE Danielle

2 - Argent / Silver



HENDEY Amanda

3 - Bronze



KROL Agnieszka



LAZINSKAIA Valeriia

Classement	Nom - Name	Pays - Country
1	LAPPAGE Danielle	CAN
2	HENDEY Amanda	USA
3	KROL Agnieszka	POL
3	LAZINSKAIA Valeriia	RUS
5	MANOLOVA Dzanan	BUL
5	UEHARA Haruna	JPN
7	SLEISZ Gabriella	HUN
8	OTGONBAT Oyuntuya	MGL
9	MALYK Yulija	UKR



# Feuille de compétition / Competition Sheet

## 11th World University Wrestling Championship



STYLE : FW 69 kg

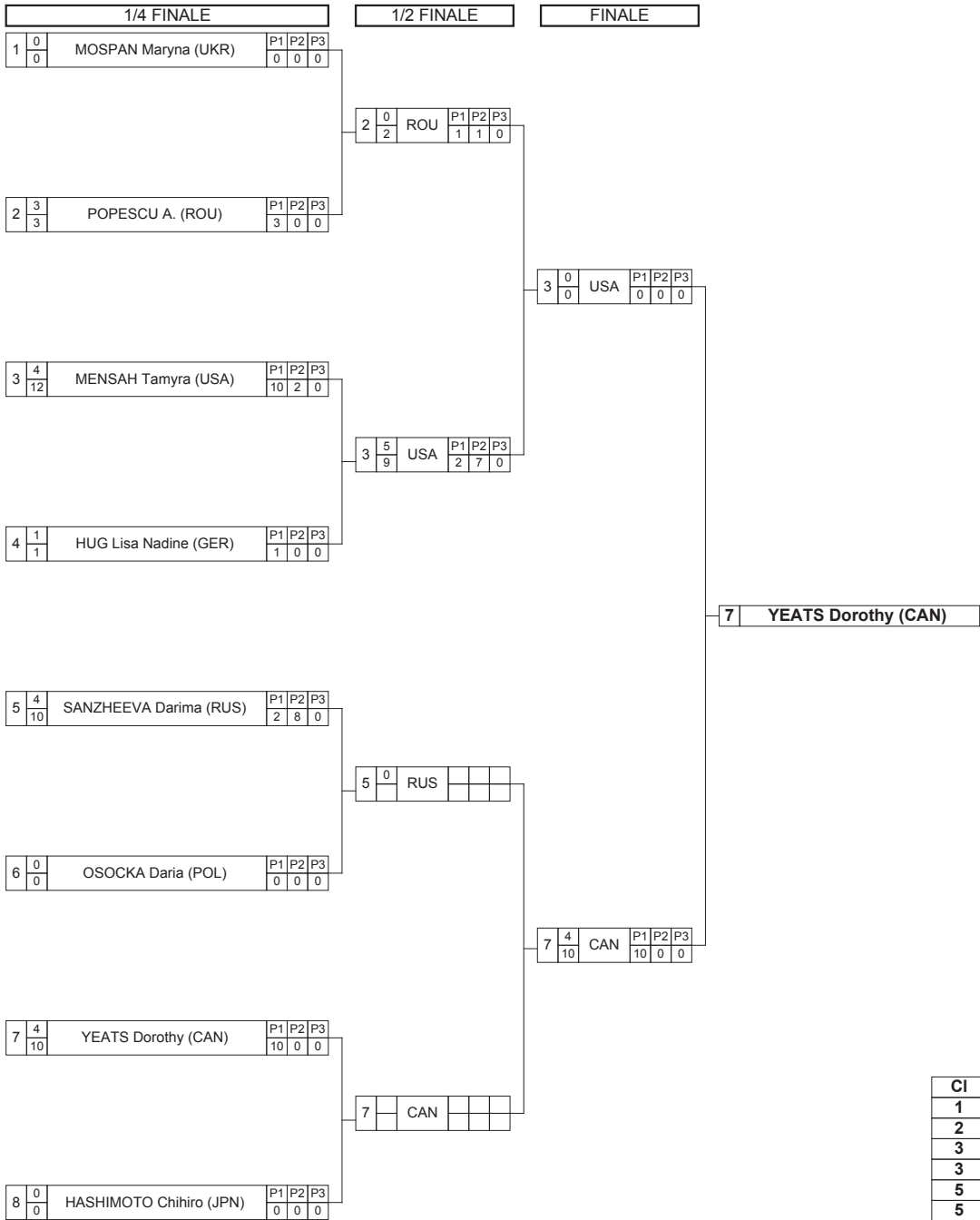

Classement

Cl	Pays	Nom
1	CAN	YEATS Dorothy
2	USA	MENSAH Tamyra
3	ROU	POPESCU Adina-Elena
3	RUS	SANZHEEVA Darima
5	GER	HUG Lisa Nadine
5	JPN	HASHIMOTO Chihiro
7	UKR	MOSPAN Maryna
8	POL	OSOCKA Daria

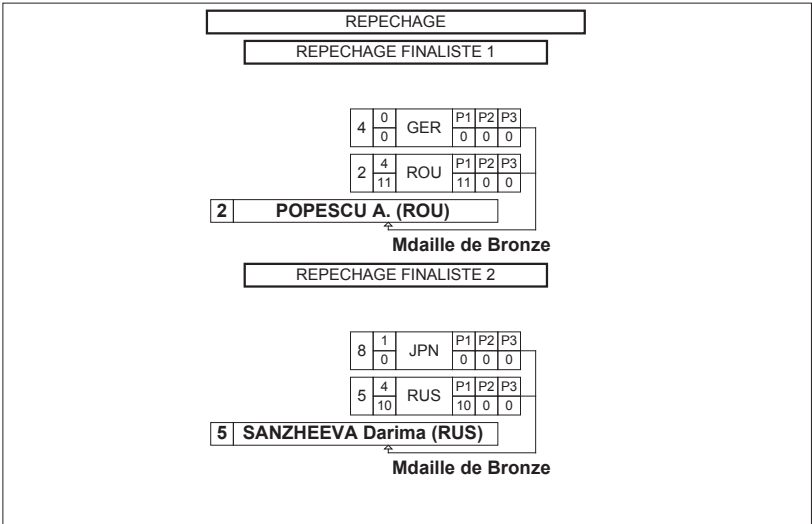



Classement

11th World University Wrestling Championship



STYLE : FW 69 kg

1 - Or / Gold



YEATS Dorothy

2 - Argent / Silver



MENSAH Tamyra

3 - Bronze



POPESCU Adina-Elena



SANZHEEVA Darima

Classement	Nom - Name	Pays - Country
1	YEATS Dorothy	CAN
2	MENSAH Tamyra	USA
3	POPESCU Adina-Elena	ROU
3	SANZHEEVA Darima	RUS
5	HUG Lisa Nadine	GER
5	HASHIMOTO Chihiro	JPN
7	MOSPAN Maryna	UKR
8	OSOCKA Daria	POL





# Feuille de compétition / Competition Sheet

## 11th World University Wrestling Championship



STYLE : FW 75 kg

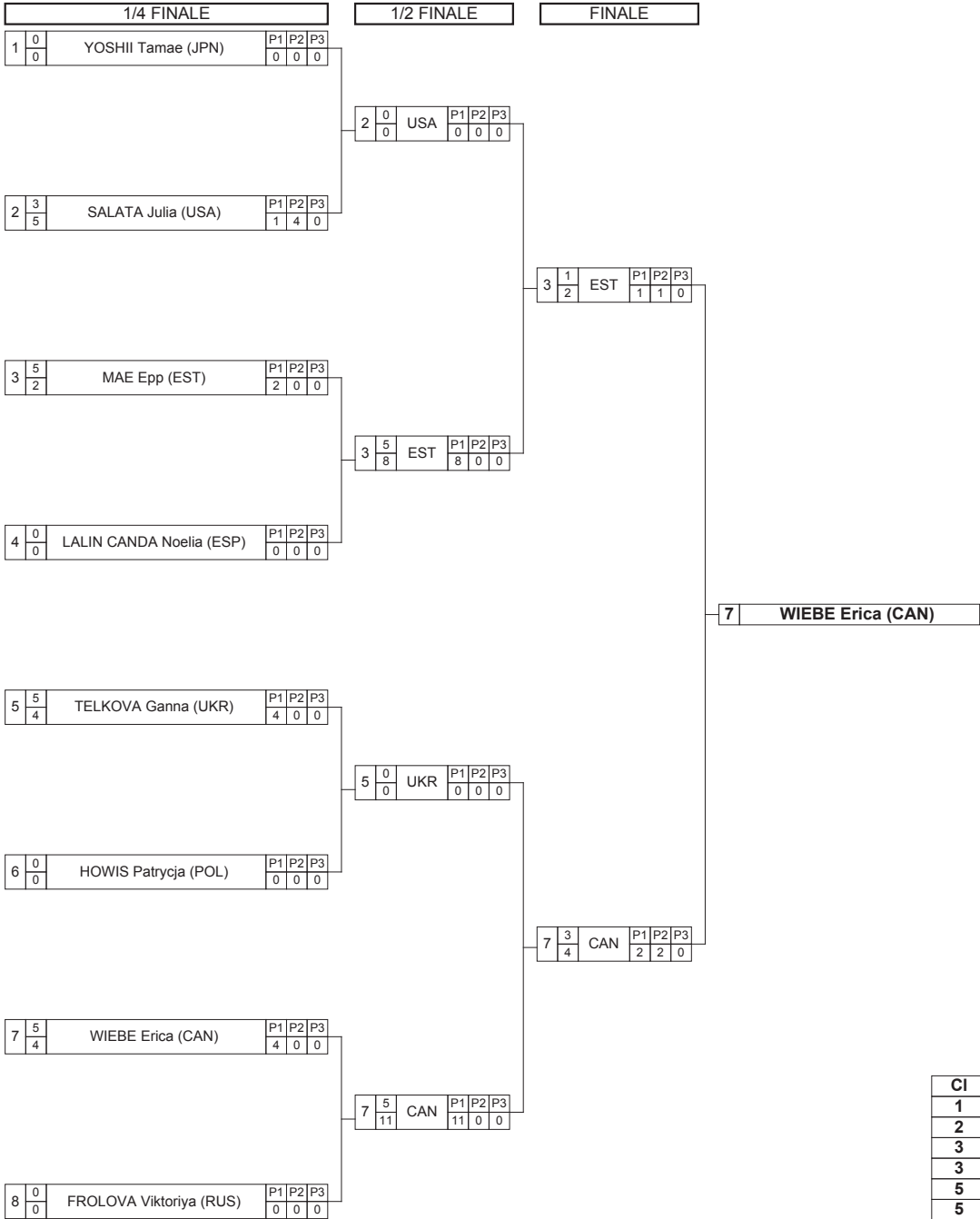

Classement

Cl	Pays	Nom
1	CAN	WIEBE Erica
2	EST	MAE Epp
3	USA	SALATA Julia
3	UKR	TELKOVA Ganna
5	ESP	LALIN CANDA Noelia
5	RUS	FROLOVA Viktoriya
7	POL	HOWIS Patrycja
8	JPN	YOSHII Tamae

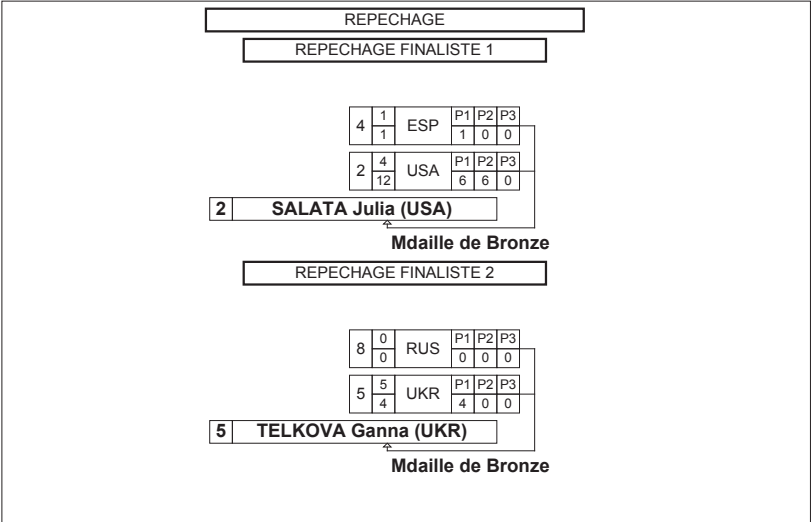



**Classement**

**11th World University Wrestling Championship**



STYLE : FW 75 kg

1 - Or / Gold



WIEBE Erica

2 - Argent / Silver



MAE Epp

3 - Bronze



SALATA Julia



TELKOVA Ganna

<b>Classement</b>	<b>Nom - Name</b>	<b>Pays - Country</b>
1	WIEBE Erica	CAN
2	MAE Epp	EST
3	SALATA Julia	USA
3	TELKOVA Ganna	UKR
5	LALIN CANDA Noelia	ESP
5	FROLOVA Viktoriya	RUS
7	HOWIS Patrycja	POL
8	YOSHII Tamae	JPN



# 11TH WORLD UNIVERSITY WRESTLING CHAMPIONSHIP



PECS (HUN)

2014-07-07 - 2014-07-12 2014

Résultats - Results

Lutte Greco-Romaine - Greco-Roman





Liste des arbitres / Referee list

11th World University Wrestling Championship



<i>N°</i>	<i>Licence</i>	<i>Pays Country</i>	<i>Nom - Last Name</i>	<i>Prénom - First Name</i>
-----------	----------------	-------------------------	------------------------	----------------------------





Liste des nations / Countries List

11th World University Wrestling Championship

STYLE GR



*Pays - Country*

	AUSTRIA	AUT
	BELARUS	BLR
	BRAZIL	BRA
	BULGARIA	BUL
	CZECH REPUBLIC	CZE
	FINLAND	FIN
	GERMANY	GER
	HUNGARY	HUN
	JAPAN	JPN
	KAZAKHSTAN	KAZ
	KYRGYZSTAN	KGZ
	MEXICO	MEX
	MOLDOVA	MDA
	POLAND	POL
	ROMANIA	ROU
	RUSSIA	RUS
	SERBIA	SRB
	SLOVAKIA	SVK
	SPAIN	ESP
	TURKEY	TUR
	UKRAINE	UKR
	UNITED STATES	USA

Nombre de nations - Number of Countries 22

**Nombre d'engagés par nation / Number of Entries By Country****11th World University Wrestling Championship**

STYLE GR

<i>Pays - Country</i>	<b>130 KG</b>	<b>59 KG</b>	<b>66 KG</b>	<b>71 KG</b>	<b>75 KG</b>	<b>80 KG</b>	<b>85 KG</b>	<b>98 KG</b>	<b>TOTAL</b>
AUT			1	1					2
BLR					1		1		2
BRA			1		1				2
BUL	1	1	1	1	1	1	1		7
CZE			1		1				2
ESP				1					1
FIN							1		1
GER			1		1	1		1	4
HUN	1	1	1	1	1	1	1	1	8
JPN	1	1	1	1	1	1	1	1	8
KAZ		1	1		1			1	4
KGZ		1							1
MDA		1	1	1	1			1	5
MEX		1							1
POL	1		1	1	1	1	1	1	7
ROU			1					1	2
RUS	1	1	1	1	1	1	1	1	8
SRB			1			1			2
SVK								1	1
TUR	1	1	1	1	1	1	1	1	8
UKR	1	1	1	1	1	1	1	1	8
USA	1	1	1	1			1	1	6
<b>TOTAL</b>	<b>8</b>	<b>11</b>	<b>16</b>	<b>11</b>	<b>13</b>	<b>9</b>	<b>10</b>	<b>12</b>	<b>90</b>

Nombre de nations - Number of Countries **22**



Liste des Engagés par pays / Entry-List By Country

11th World University Wrestling Championship

STYLE GR



**AUSTRIA (AUT)**

**Lutteur(s) / Wrestler(s) :**

66 kg	PUFFER, Benedikt
71 kg	FUCHSREITER, Stefan

**BELARUS (BLR)**

**Lutteur(s) / Wrestler(s) :**

75 kg	HENUVEINA, Aliaksandr
85 kg	VALKHANOVICH, Yauhen

**BRAZIL (BRA)**

**Lutteur(s) / Wrestler(s) :**

66 kg	LIMA DINIZ DA SILVA, Gil Leon
75 kg	MENEZES WANDERLEY, Wagner Claudius

**BULGARIA (BUL)**

**Lutteur(s) / Wrestler(s) :**

130 kg	DIMITROV, Lyubomir
59 kg	BORISOV, Andrey
66 kg	ATANASOV, Halil
71 kg	DIMITROV, Milen
75 kg	NAYDENOV, Stilyan
80 kg	ALEKSANDROV, Daniel
85 kg	BAYRYAKOV, Nikolay

**CZECH REPUBLIC (CZE)**

**Lutteur(s) / Wrestler(s) :**

66 kg	MORBITZER, Matous
75 kg	VARGA, Oldrich

**FINLAND (FIN)**

**Lutteur(s) / Wrestler(s) :**

85 kg	KIVIMAKI, Marko
-------	-----------------





Liste des Engagés par pays / Entry-List By Country

11th World University Wrestling Championship

STYLE GR



**GERMANY (GER)**

**Lutteur(s) / Wrestler(s) :**

66 kg	STADE, Toni
75 kg	WEINHOLD, Francis
80 kg	BRAUN, Marius
98 kg	RADINGER, Felix

**HUNGARY (HUN)**

**Lutteur(s) / Wrestler(s) :**

130 kg	LAM, Balint
59 kg	NEMETH, Zsolt
66 kg	JAGER, Krisztian
71 kg	LORINCZ, Tamas
75 kg	SZABO, Laszlo
80 kg	MADARASI, Gabor
85 kg	TOSI, Janos
98 kg	NEMETH, Ivan

**JAPAN (JPN)**

**Lutteur(s) / Wrestler(s) :**

130 kg	SONODA, Arata
59 kg	MATSUZAWA, Rikiya
66 kg	NAKAI, Kenta
71 kg	NAKAMURA, Naoya
75 kg	SAKABE, Soh
80 kg	MAETA, Yuya
85 kg	HOSHI, Shoya
98 kg	YONEHIRA, Yasuhiro

**KAZAKHSTAN (KAZ)**

**Lutteur(s) / Wrestler(s) :**

59 kg	BAIMAGAMBETOV, AKAN
66 kg	UTEPCBERGENOV, NURTAS
75 kg	KOCHIYEV, Rashid
98 kg	NASTOCHENKO, Ilya



Liste des Engagés par pays / Entry-List By Country

11th World University Wrestling Championship

STYLE GR



**KYRGYZSTAN (KGZ)**

Lutteur(s) / Wrestler(s) :

59 kg ZHOLCHUBEKOV, Kanybek

**MEXICO (MEX)**

Lutteur(s) / Wrestler(s) :

59 kg ORRANTIA MERVIN, Leyua

**MOLDOVA (MDA)**

Lutteur(s) / Wrestler(s) :

59 kg MAMULAT, Maxim  
66 kg ISLAMOV, Donior  
71 kg JECOV, Grigorii  
75 kg SEVCIUC, Petru  
98 kg CAZAC, Marin

**POLAND (POL)**

Lutteur(s) / Wrestler(s) :

130 kg FAFINSKI, Mateusz  
66 kg MELKUMOV, Edgar  
71 kg MALISZEWSKI, Jacek  
75 kg KULYNYCZ, Arkadiusz  
80 kg PRZEPIORKA, Piotr  
85 kg MICHALIK, Tadeusz  
98 kg OLEJNICZAK, Marcin

**ROMANIA (ROU)**

Lutteur(s) / Wrestler(s) :

66 kg CARPEN, Georgian  
98 kg ALEXUC CIURARIU, Alin

**RUSSIA (RUS)**

Lutteur(s) / Wrestler(s) :

130 kg VAINSHEIN, Boris  
59 kg DENILKHANOV, Mansur



## Liste des Engagés par pays / Entry-List By Country

### 11th World University Wrestling Championship



#### STYLE GR

66 kg	SHOKAROV, Marat
71 kg	VYSOTIN, Evgenii
75 kg	BYCHKOV, Ivan
80 kg	NUNUSHIAN, Ogan
85 kg	GRACHEV, Nikolay
98 kg	KONNOV, Alexander

#### SERBIA (SRB)

##### Lutteur(s) / Wrestler(s) :

66 kg	POPOVIC, Milan
80 kg	MARKOVIC, Milan

#### SLOVAKIA (SVK)

##### Lutteur(s) / Wrestler(s) :

98 kg	LENGYEL, David
-------	----------------

#### SPAIN (ESP)

##### Lutteur(s) / Wrestler(s) :

71 kg	GARCIA GARCIA, Pablo
-------	----------------------

#### TURKEY (TUR)

##### Lutteur(s) / Wrestler(s) :

130 kg	GUZEL, Ismail
59 kg	UCUNCU, Fatih
66 kg	GUNAL, Abdulsamet
71 kg	ARZIMANOV, Vasif
75 kg	AYVAZOGLU, Refik
80 kg	ATEM, Aslan
85 kg	BASAR, Metehan
98 kg	ALKAN, Mahmut

#### UKRAINE (UKR)

##### Lutteur(s) / Wrestler(s) :

130 kg	KUCHMII, Mykola
59 kg	PYSLAR, Dmytro
66 kg	GAIDUK, Roman



Liste des Engagés par pays / Entry-List By Country

11th World University Wrestling Championship

STYLE GR



71 kg	PROKOFIEV, Iurii
75 kg	KUKHTA, Olaksandr
80 kg	GLADKYKH, Andrii
85 kg	MANIN, Vladyslav
98 kg	VASYLIEV, Volodymyr

**UNITED STATES (USA)**

**Lutteur(s) / Wrestler(s) :**

130 kg	ERICKSON, Toby
59 kg	JONES, Sam
66 kg	MOSS, Kade
71 kg	SMITH, Patrick
85 kg	RAU, Josef
98 kg	ELOR, Orry



# Feuille de compétition / Competition Sheet

## 11th World University Wrestling Championship



STYLE : GR 130 kg

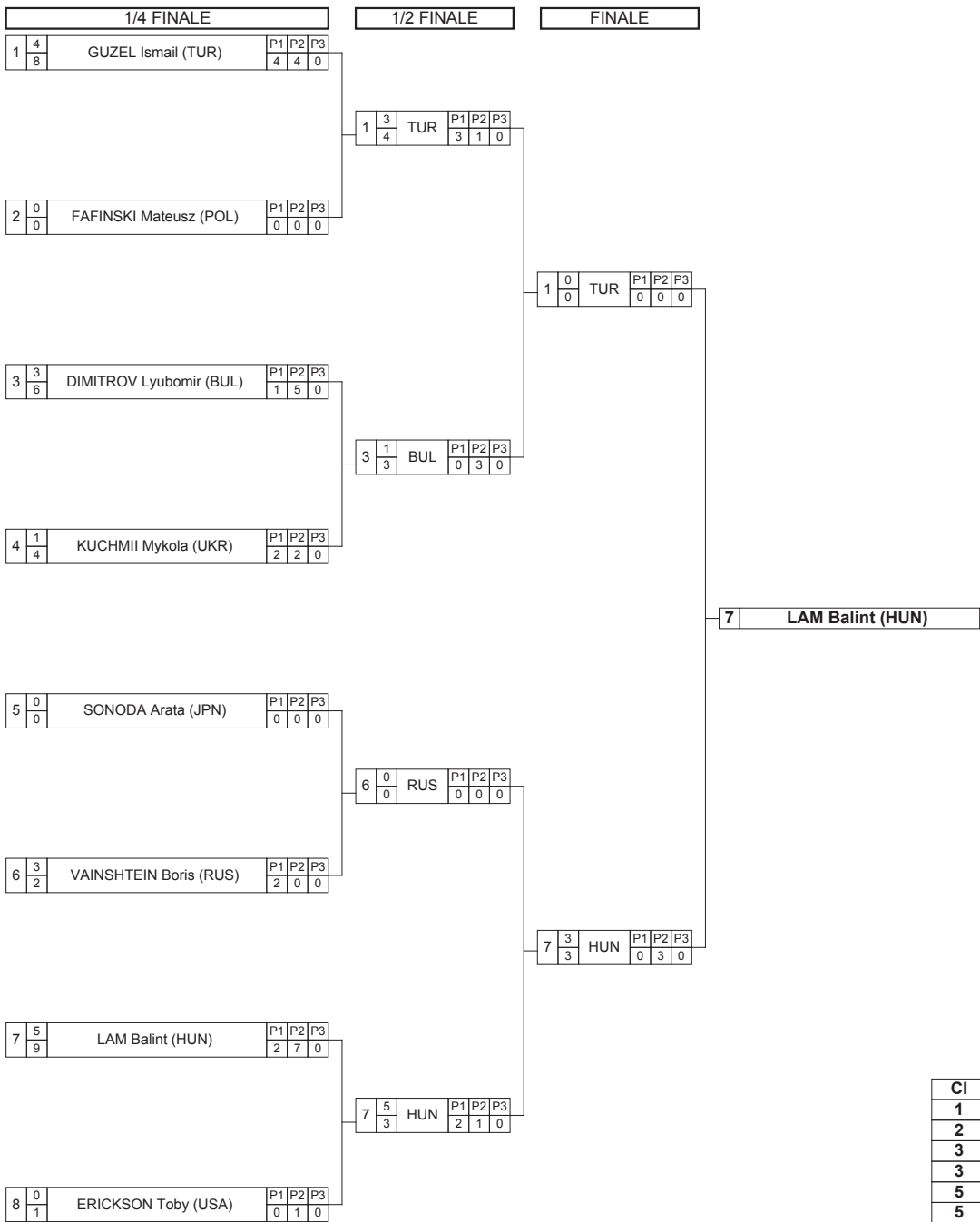

Classement

Cl	Pays	Nom
1	HUN	LAM Balint
2	TUR	GUZEL Ismail
3	POL	FAFINSKI Mateusz
3	RUS	VAINSHTEIN Boris
5	BUL	DIMITROV Lyubomir
5	USA	ERICKSON Toby
7	UKR	KUCHMII Mykola

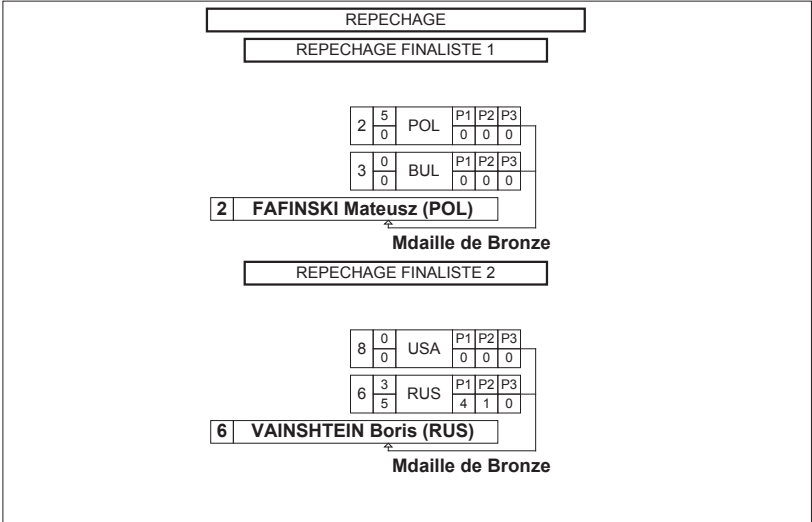



**Classement**

**11th World University Wrestling Championship**



STYLE : GR 130 kg

1 - Or / Gold



LAM Balint

2 - Argent / Silver



GUZEL Ismail

3 - Bronze



FAFINSKI Mateusz



VAINSHTEIN Boris

<i>Classement</i>	<i>Nom - Name</i>	<i>Pays - Country</i>
1	LAM Balint	HUN
2	GUZEL Ismail	TUR
3	FAFINSKI Mateusz	POL
3	VAINSHTEIN Boris	RUS
5	DIMITROV Lyubomir	BUL
5	ERICKSON Toby	USA
7	KUCHMII Mykola	UKR



# Feuille de compétition / Competition Sheet

## 11th World University Wrestling Championship



STYLE : GR 59 kg

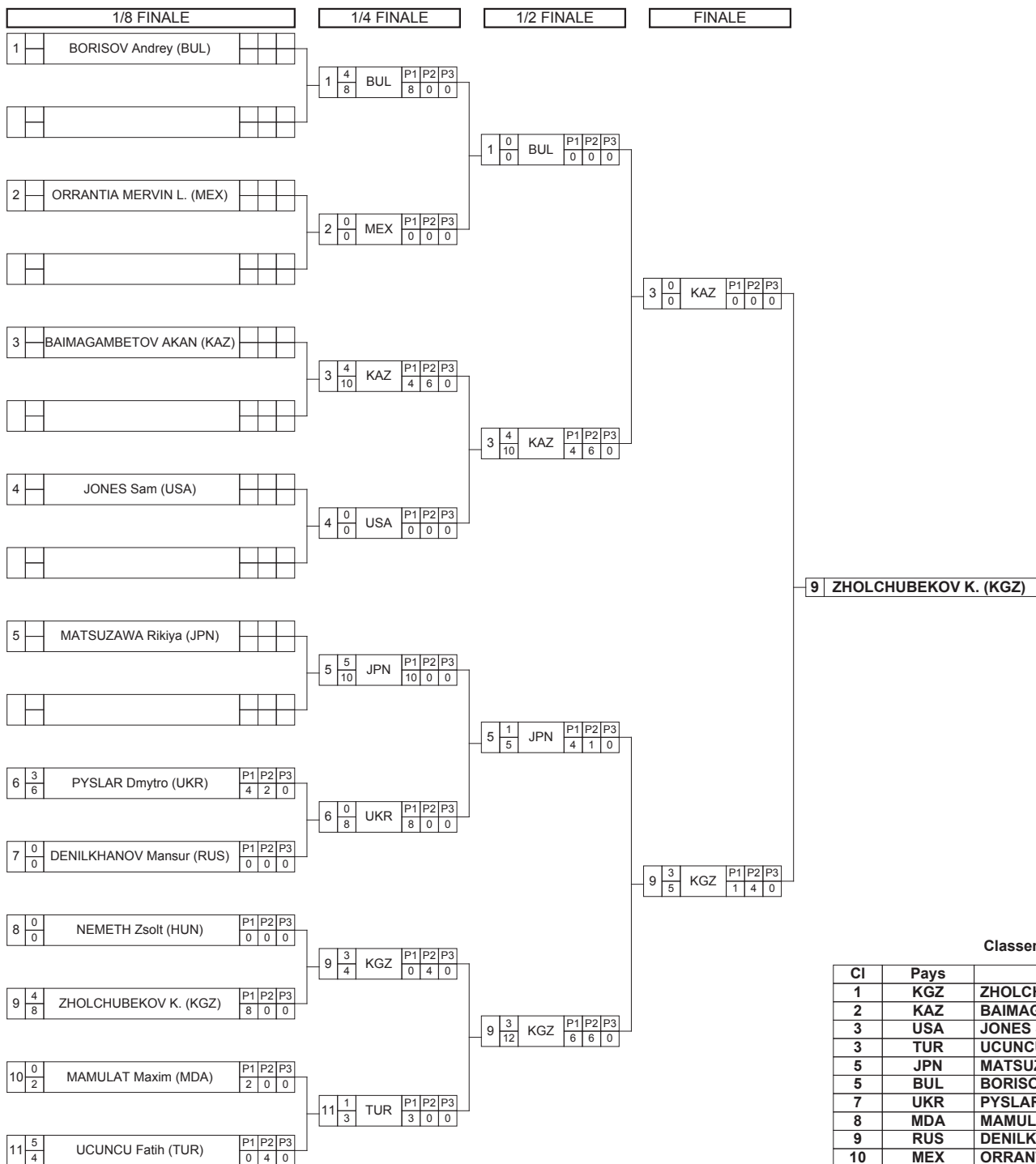

### Classement

Cl	Pays	Nom
1	KGZ	ZHOLCHUBEKOV Kanybek
2	KAZ	BAIMAGAMBETOV AKAN
3	USA	JONES Sam
3	TUR	UCUNCU Fatih
5	JPN	MATSUZAWA Rikiya
5	BUL	BORISOV Andrey
7	UKR	PYSLAR Dmytro
8	MDA	MAMULAT Maxim
9	RUS	DENILKHANOV Mansur
10	MEX	ORRANTIA MERVIN Leyua
11	HUN	NEMETH Zsolt

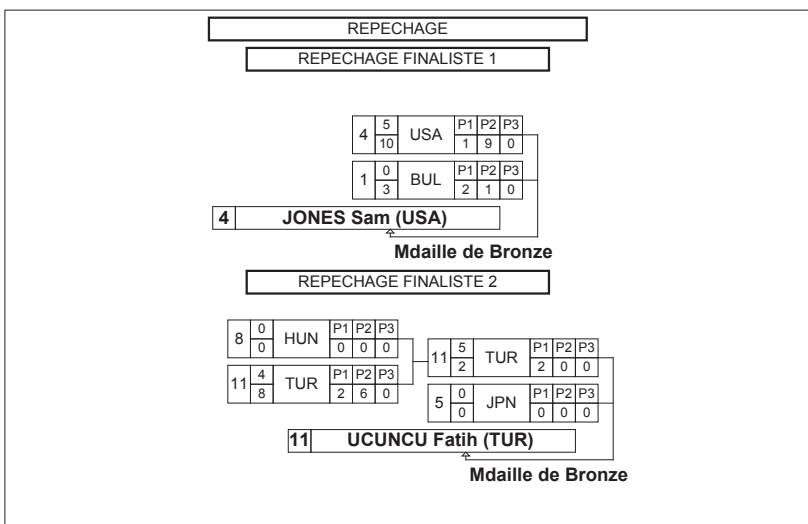



Classement

11th World University Wrestling Championship



STYLE : GR 59 kg

1 - Or / Gold



ZHOLCHUBEKOV Kanybek

2 - Argent / Silver



BAIMAGAMBETOV AKAN

3 - Bronze



JONES Sam



UCUNCU Fatih

Classement	Nom - Name	Pays - Country
1	ZHOLCHUBEKOV K.	KGZ
2	BAIMAGAMBETOV AKAN	KAZ
3	JONES Sam	USA
3	UCUNCU Fatih	TUR
5	MATSUZAWA Rikiya	JPN
5	BORISOV Andrey	BUL
7	PYSLAR Dmytro	UKR
8	MAMULAT Maxim	MDA
9	DENILKHANOV Mansur	RUS
10	ORRANTIA MERVIN L.	MEX
11	NEMETH Zsolt	HUN





# Feuille de compétition / Competition Sheet

## 11th World University Wrestling Championship



STYLE : GR 66 kg



16 JAGER Krisztian (HUN)

### Classement

Cl	Pays	Nom
1	HUN	JAGER Krisztian
2	TUR	GUNAL Abdulsamet
3	MDA	ISLAMOV Donior
3	UKR	GAIDUK Roman
5	KAZ	UTEPPERGENOV NURTAS
5	POL	MELKUMOV Edgar
7	JPN	NAKAI Kenta
8	USA	MOSS Kade
9	ROU	CARPEN Georgian
10	CZE	MORBITZER Matous
11	AUT	PUFFER Benedikt
12	RUS	SHOKAROV Marat
13	GER	STADE Toni
14	BUL	ATANASOV Halil
15	SRB	POPOVIC Milan
16	BRA	LIMA DINIZ DA SILVA Gil Leon

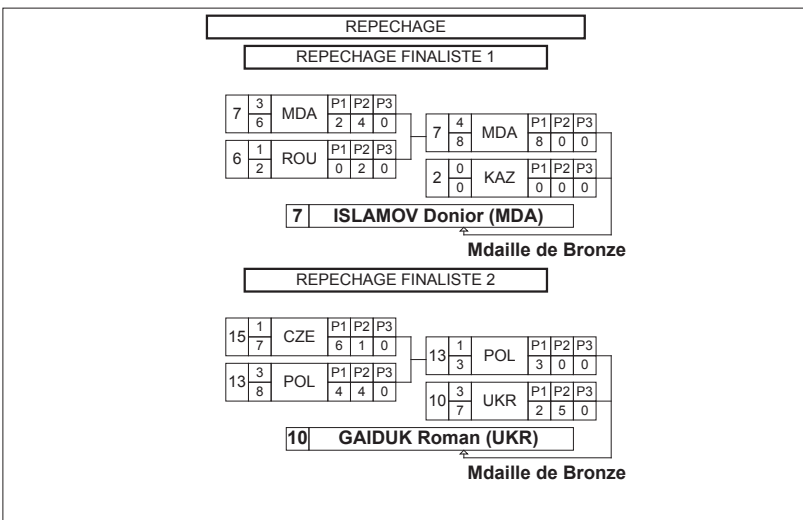



Classement

11th World University Wrestling Championship



STYLE : GR 66 kg

1 - Or / Gold



JAGER Krisztian

2 - Argent / Silver



GUNAL Abdulsamet

3 - Bronze



ISLAMOV Donior



GAIDUK Roman

Classement	Nom - Name	Pays - Country
1	JAGER Krisztian	HUN
2	GUNAL Abdulsamet	TUR
3	ISLAMOV Donior	MDA
3	GAIDUK Roman	UKR
5	UTEPPERGENOV NURTAS	KAZ
5	MELKUMOV Edgar	POL
7	NAKAI Kenta	JPN
8	MOSS Kade	USA
9	CARPEN Georgian	ROU
10	MORBITZER Matous	CZE
11	PUFFER Benedikt	AUT
12	SHOKAROV Marat	RUS
13	STADE Toni	GER
14	ATANASOV Halil	BUL
15	POPOVIC Milan	SRB
16	LIMA DINIZ DA SILVA G.	BRA



# Feuille de compétition / Competition Sheet

## 11th World University Wrestling Championship



STYLE : GR 71 kg

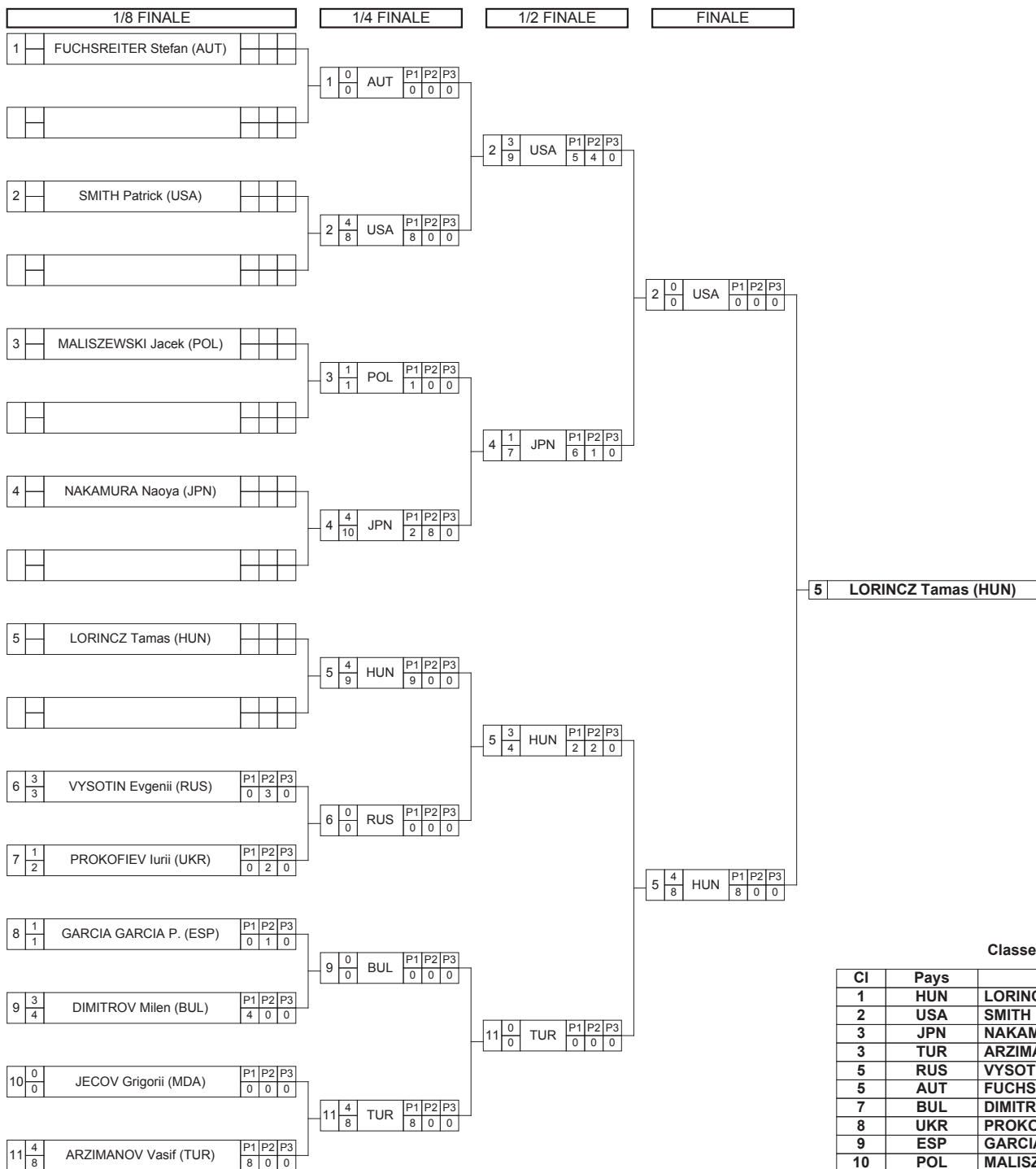

### Classement

Cl	Pays	Nom
1	HUN	LORINCZ Tamas
2	USA	SMITH Patrick
3	JPN	NAKAMURA Naoya
3	TUR	ARZIMANOV Vasif
5	RUS	VYSOTIN Evgenii
5	AUT	FUCHSREITER Stefan
7	BUL	DIMITROV Milen
8	UKR	PROKOFIEV Iurii
9	ESP	GARCIA GARCIA Pablo
10	POL	MALISZEWSKI Jacek
11	MDA	JECOV Grigorii

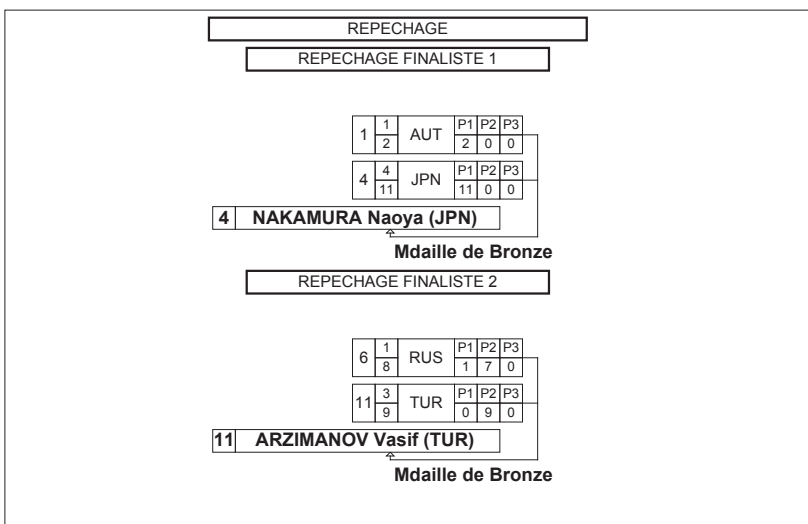



**Classement**

**11th World University Wrestling Championship**



STYLE : GR 71 kg

1 - Or / Gold



LORINCZ Tamas

2 - Argent / Silver



SMITH Patrick

3 - Bronze



NAKAMURA Naoya



ARZIMANOV Vasif

<i>Classement</i>	<i>Nom - Name</i>	<i>Pays - Country</i>
1	LORINCZ Tamas	HUN
2	SMITH Patrick	USA
3	NAKAMURA Naoya	JPN
3	ARZIMANOV Vasif	TUR
5	VYSOTIN Evgenii	RUS
5	FUCHSREITER Stefan	AUT
7	DIMITROV Milen	BUL
8	PROKOFIEV Iurii	UKR
9	GARCIA GARCIA Pablo	ESP
10	MALISZEWSKI Jacek	POL
11	JECOV Grigorii	MDA



# Feuille de compétition / Competition Sheet

## 11th World University Wrestling Championship



STYLE : GR 75 kg

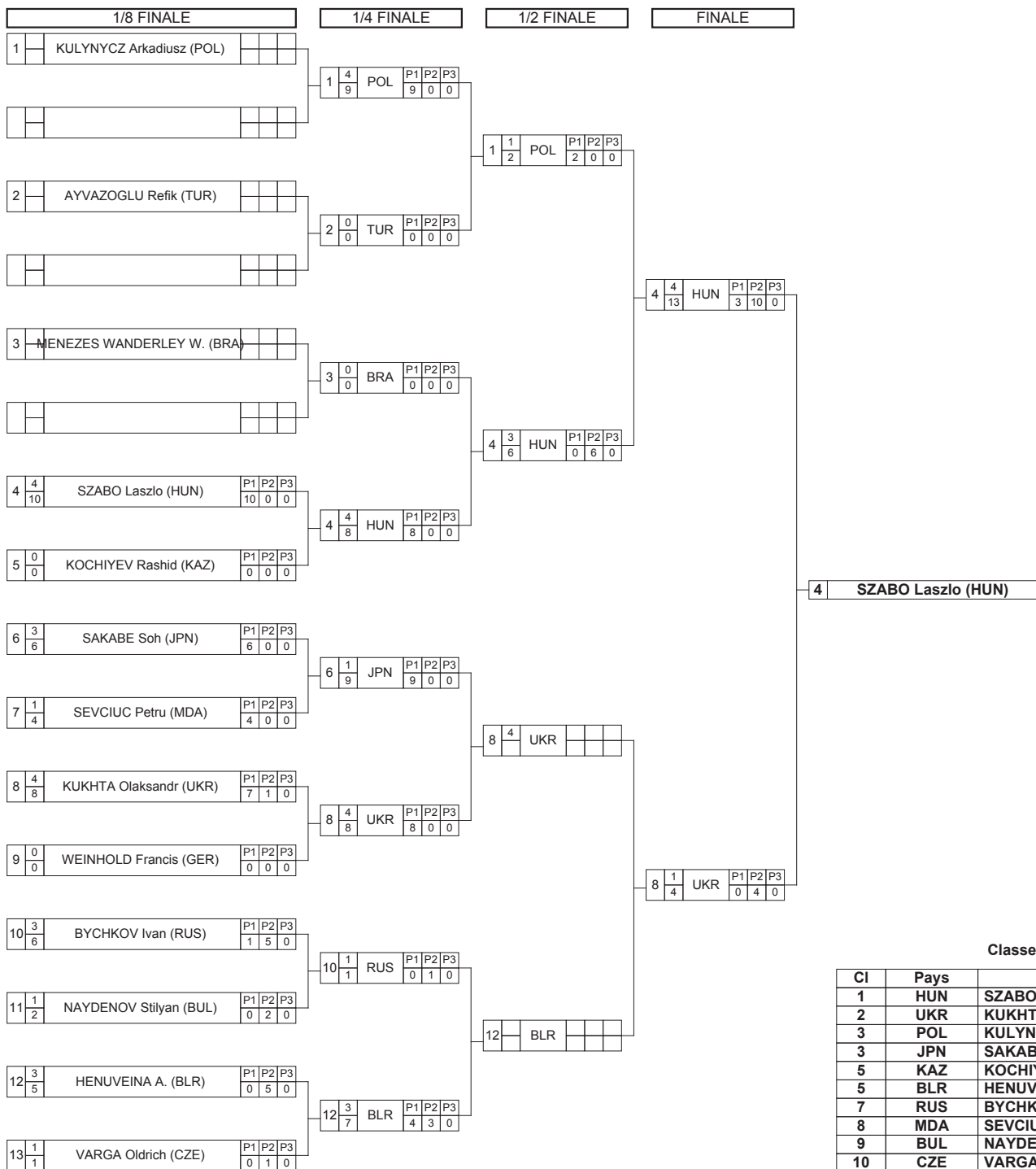

### Classement

Cl	Pays	Nom
1	HUN	SZABO Laszlo
2	UKR	KUKHTA Olaksandr
3	POL	KULYNYCZ Arkadiusz
3	JPN	SAKABE Soh
5	KAZ	KOCHIYEV Rashid
5	BLR	HENUVEINA Aliaksandr
7	RUS	BYCHKOV Ivan
8	MDA	SEVCIUC Petru
9	BUL	NAYDENOV Stilyan
10	CZE	VARGA Oldrich
11	GER	WEINHOLD Francis
12	BRA	MENEZES WANDERLEY Wagner
13	TUR	AYVAZOGLU Refik

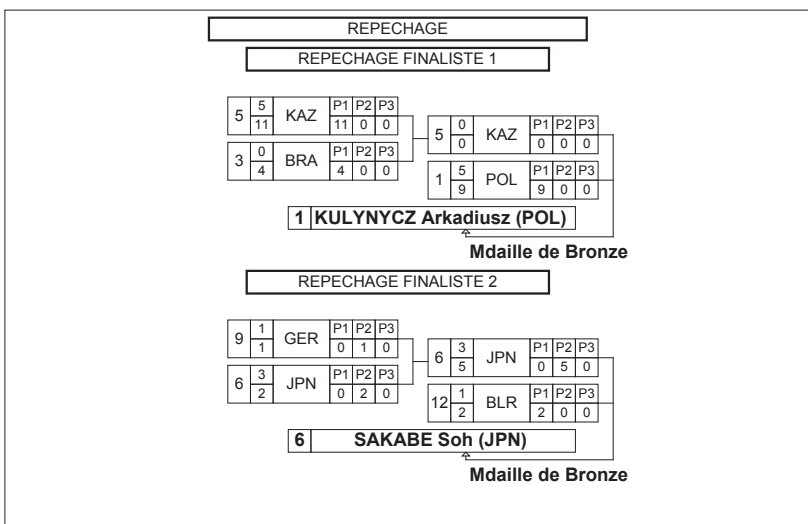



Classement

11th World University Wrestling Championship



STYLE : GR 75 kg

1 - Or / Gold



SZABO Laszlo

2 - Argent / Silver



KUKHTA Olaksandr

3 - Bronze



KULYNYCZ Arkadiusz



SAKABE Soh

Classement	Nom - Name	Pays - Country
1	SZABO Laszlo	HUN
2	KUKHTA Olaksandr	UKR
3	KULYNYCZ Arkadiusz	POL
3	SAKABE Soh	JPN
5	KOCHIYEV Rashid	KAZ
5	HENUVEINA A.	BLR
7	BYCHKOV Ivan	RUS
8	SEVCIUC Petru	MDA
9	NAYDENOV Stilyan	BUL
10	VARGA Oldrich	CZE
11	WEINHOLD Francis	GER
12	MENEZES WANDERLEY W.	BRA
13	AYVAZOGLU Refik	TUR



# Feuille de compétition / Competition Sheet

## 11th World University Wrestling Championship



STYLE : GR 80 kg

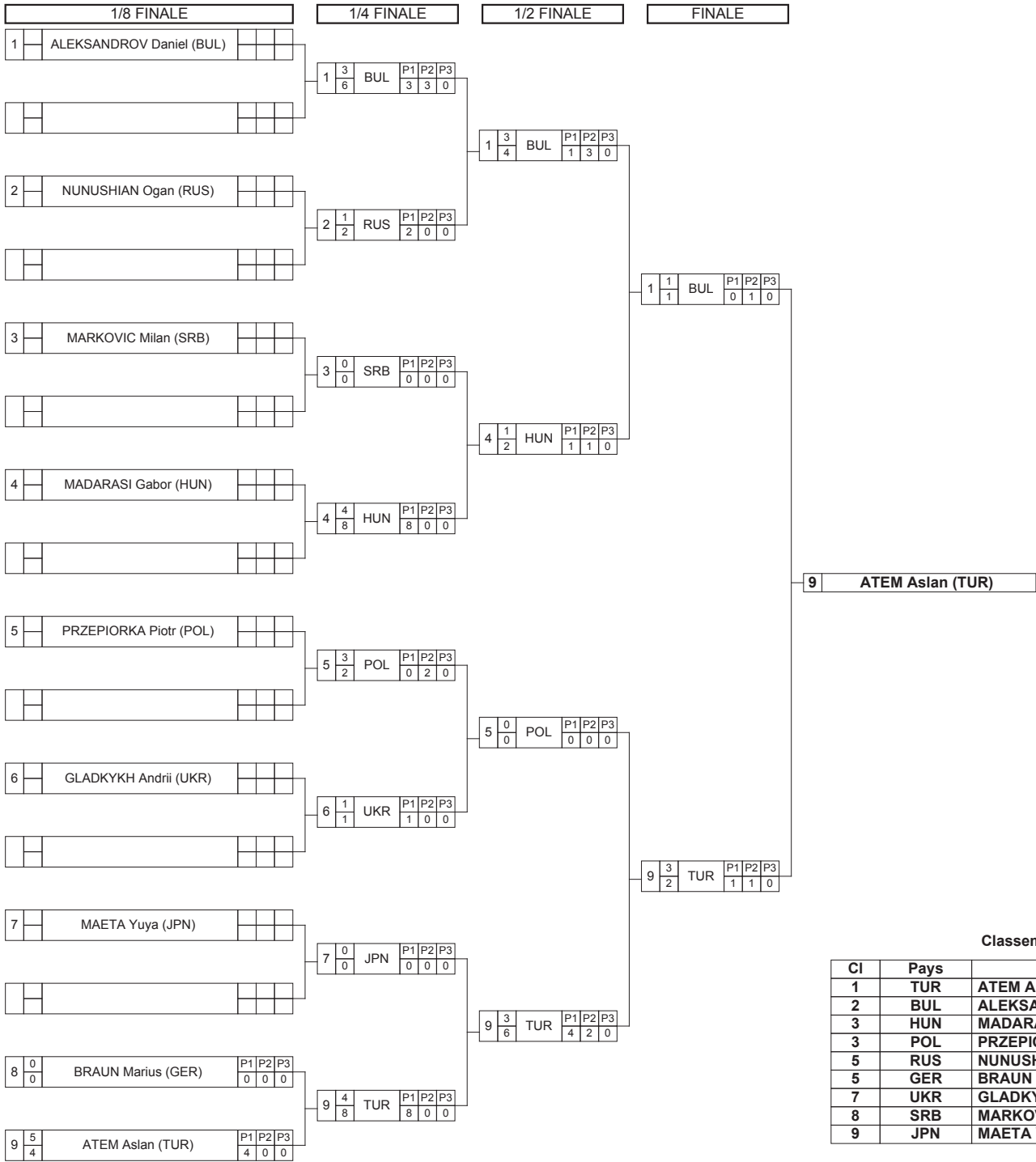

Classement

Cl	Pays	Nom
1	TUR	ATEM Aslan
2	BUL	ALEKSANDROV Daniel
3	HUN	MADARASI Gabor
3	POL	PRZEPIORKA Piotr
5	RUS	NUNUSHIAN Ogan
5	GER	BRAUN Marius
7	UKR	GLADKYKH Andrii
8	SRB	MARKOVIC Milan
9	JPN	MAETA Yuya

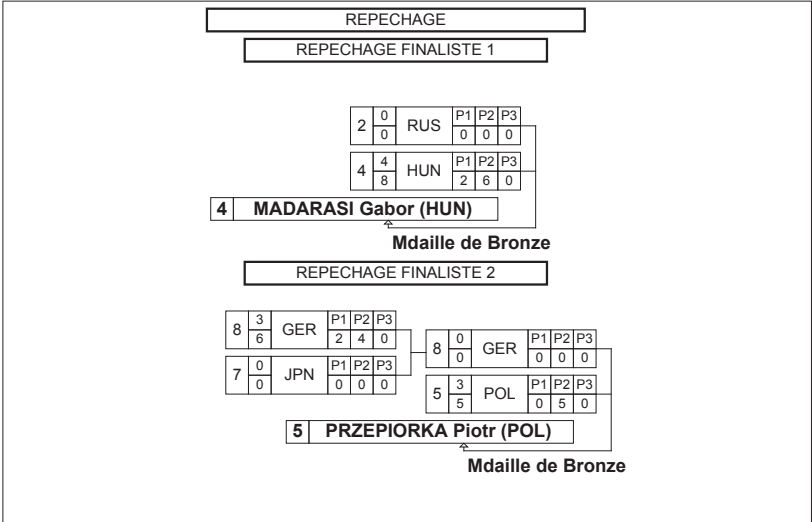



**Classement**

**11th World University Wrestling Championship**



STYLE : GR 80 kg

1 - Or / Gold



ATEM Aslan

2 - Argent / Silver



ALEKSANDROV Daniel

3 - Bronze



MADARASI Gabor



PRZEPIORKA Piotr

<i>Classement</i>	<i>Nom - Name</i>	<i>Pays - Country</i>
1	ATEM Aslan	TUR
2	ALEKSANDROV Daniel	BUL
3	MADARASI Gabor	HUN
3	PRZEPIORKA Piotr	POL
5	NUNUSHIAN Ogan	RUS
5	BRAUN Marius	GER
7	GLADKYKH Andrii	UKR
8	MARKOVIC Milan	SRB
9	MAETA Yuya	JPN





# Feuille de compétition / Competition Sheet

## 11th World University Wrestling Championship



STYLE : GR 85 kg

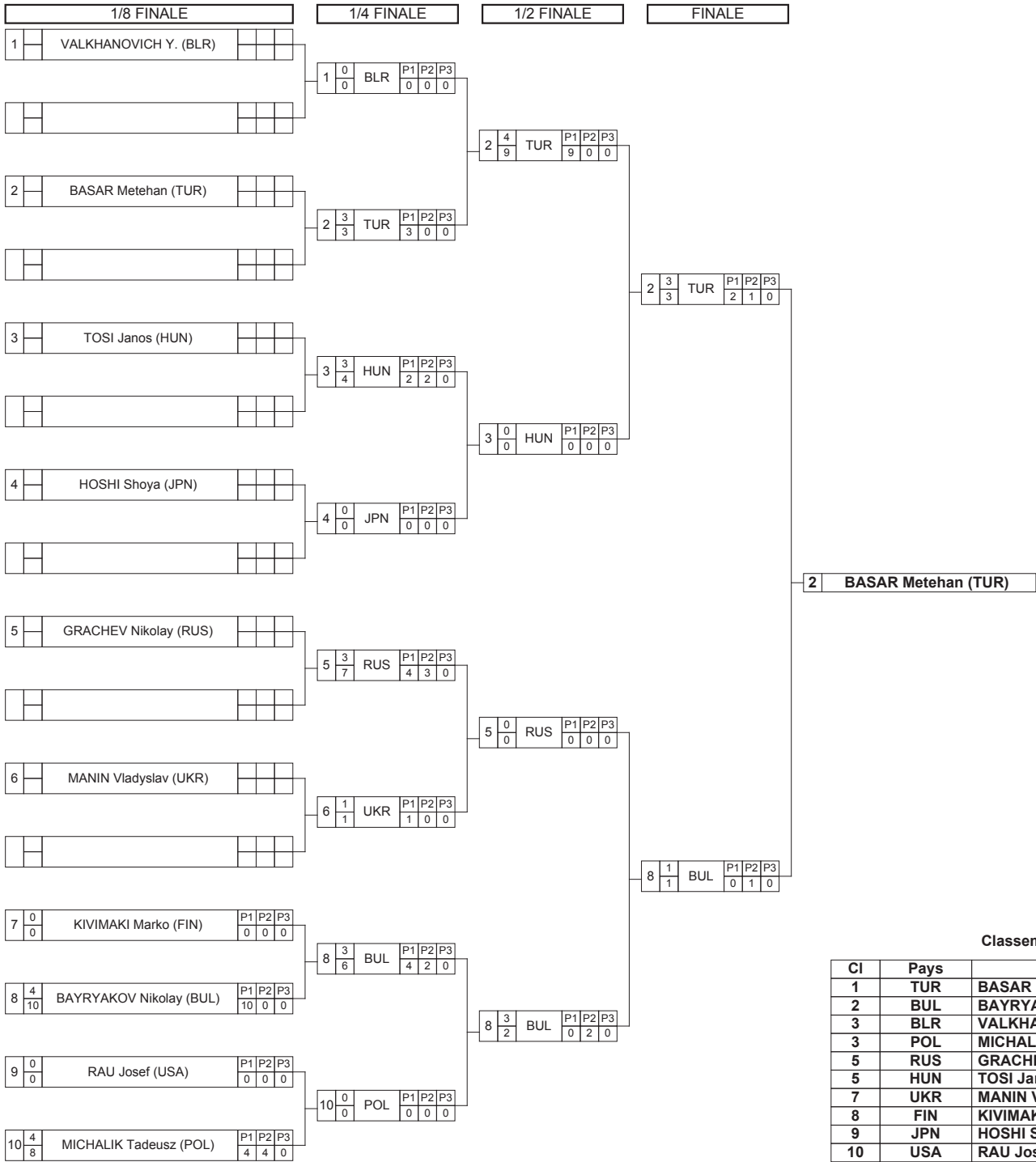

### Classement

Cl	Pays	Nom
1	TUR	BASAR Metehan
2	BUL	BAYRYAKOV Nikolay
3	BLR	VALKHANOVICH Yauhen
3	POL	MICHALIK Tadeusz
5	RUS	GRACHEV Nikolay
5	HUN	TOSI Janos
7	UKR	MANIN Vladyslav
8	FIN	KIVIMAKI Marko
9	JPN	HOSHI Shoya
10	USA	RAU Josef

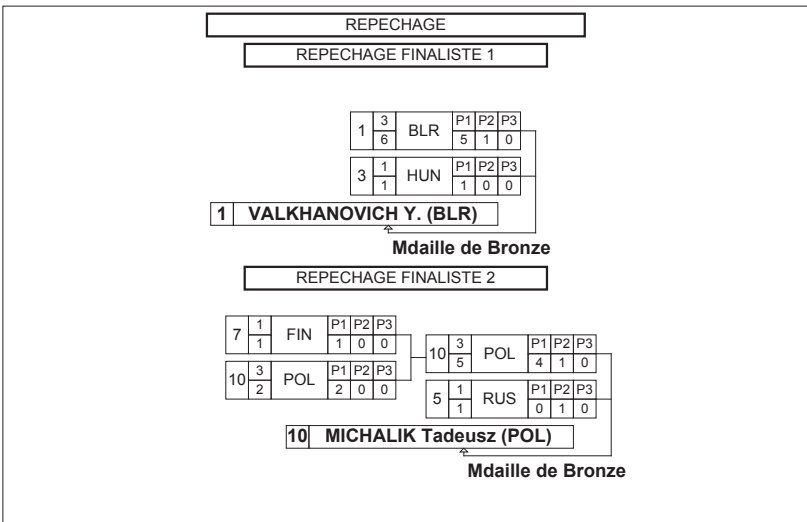



**Classement**

**11th World University Wrestling Championship**

STYLE : GR 85 kg



1 - Or / Gold



BASAR Metehan

2 - Argent / Silver



BAYRYAKOV Nikolay

3 - Bronze



VALKHANOVICH Yauhen



MICHALIK Tadeusz

<i>Classement</i>	<i>Nom - Name</i>	<i>Pays - Country</i>
1	BASAR Metehan	TUR
2	BAYRYAKOV Nikolay	BUL
3	VALKHANOVICH Yauhen	BLR
3	MICHALIK Tadeusz	POL
5	GRACHEV Nikolay	RUS
5	TOSI Janos	HUN
7	MANIN Vladyslav	UKR
8	KIVIMAKI Marko	FIN
9	HOSHI Shoya	JPN
10	RAU Josef	USA



# Feuille de compétition / Competition Sheet

## 11th World University Wrestling Championship



STYLE : GR 98 kg

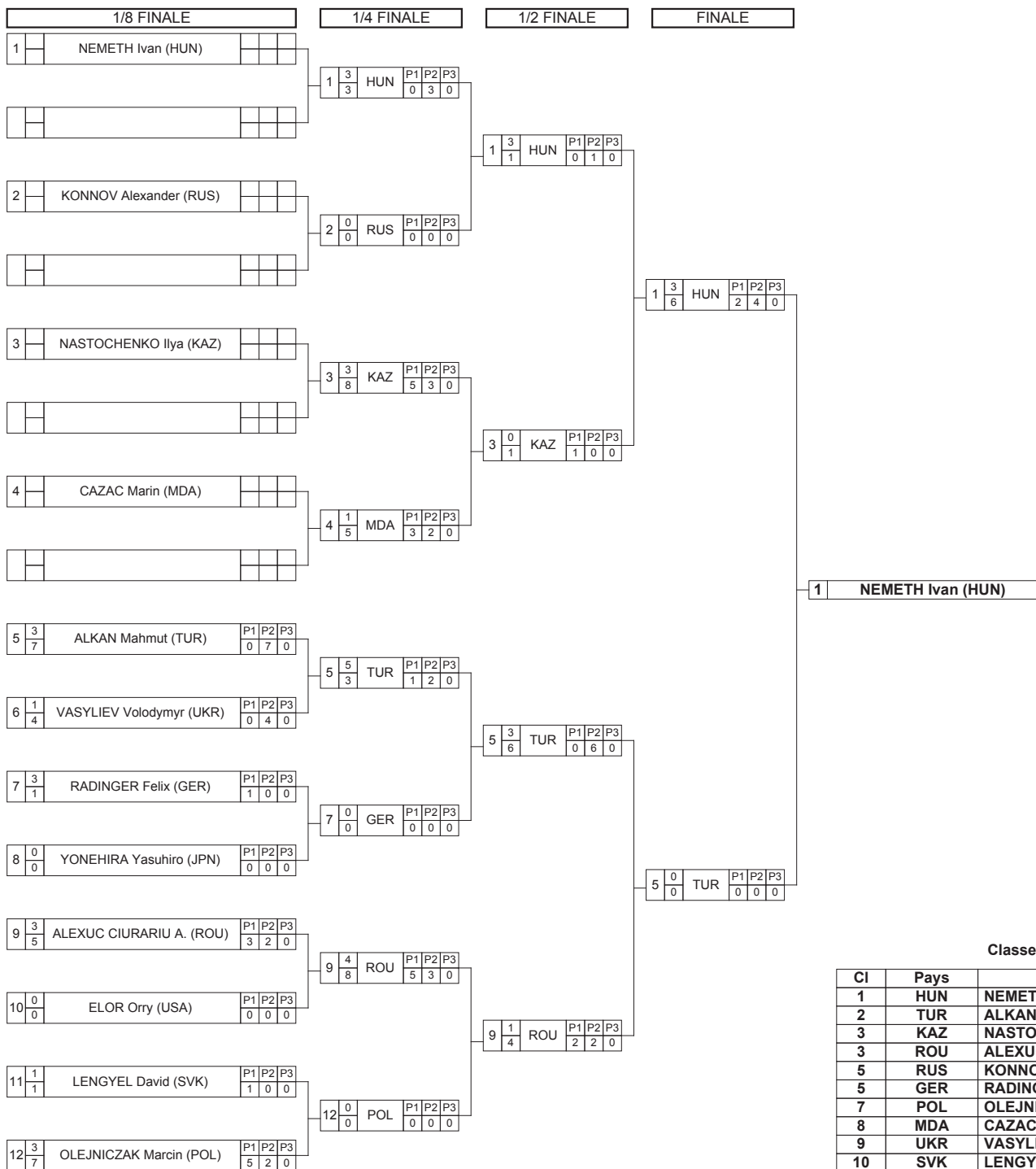

### Classement

Cl	Pays	Nom
1	HUN	NEMETH Ivan
2	TUR	ALKAN Mahmut
3	KAZ	NASTOCHENKO Ilya
3	ROU	ALEXUC CIURARIU Alin
5	RUS	KONNOV Alexander
5	GER	RADINGER Felix
7	POL	OLEJNICZAK Marcin
8	MDA	CAZAC Marin
9	UKR	VASYLIEV Volodymyr
10	SVK	LENGYEL David
11	JPN	YONEHIRA Yasuhiro
12	USA	ELOR Orry

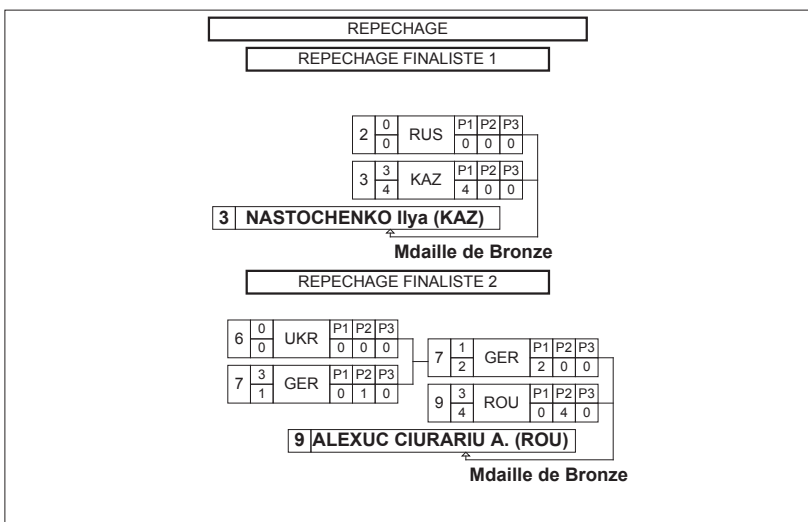



Classement

11th World University Wrestling Championship



STYLE : GR 98 kg

1 - Or / Gold



NEMETH Ivan

2 - Argent / Silver



ALKAN Mahmut

3 - Bronze



NASTOCHENKO Ilya



ALEXUC CIURARIU Alin

Classement	Nom - Name	Pays - Country
1	NEMETH Ivan	HUN
2	ALKAN Mahmut	TUR
3	NASTOCHENKO Ilya	KAZ
3	ALEXUC CIURARIU A.	ROU
5	KONNOV Alexander	RUS
5	RADINGER Felix	GER
7	OLEJNICZAK Marcin	POL
8	CAZAC Marin	MDA
9	VASYLIEV Volodymyr	UKR
10	LENGYEL David	SVK
11	YONEHIRA Yasuhiro	JPN
12	ELOR Orry	USA

